



Automation for a Changing World

Delta High Performance / Standard Compact Drive MH300 Series / MS300 Series



www.deltaww.com



DELTA
Smarter. Greener. Together.

Compact and Intelligent

The new standard for micro drives

The automation industry today continues to face challenges such as increasing competition and rising costs. In addition to improving productivity and reducing labor, the driving force for automation is the shift to higher efficiency, optimal quality, and most importantly, flexibility and compatibility for a wide range of applications.

Delta's MH300 and MS300 series are the new generation high performance and standard compact vector control drives that inherits Delta's drive technology with more advanced functions included for higher application flexibility -- all in a compact drive that has been reduced 40% in size.

A variety of essential functions are built-in as standard, including: PLC capacity for simple programming needs, communication slots for various communication cards, and a USB port to make data uploads and downloads fast and easy. This saves the need for additional hardware, while providing more installation space for the power cabinet. Other key features include: Support for both IM and PM motor control for application flexibility, an STO function to ensure worry-free operation while protecting facilities from damage, and a simplified wiring process with a new screwless wiring design of terminal blocks for quick installation.

Saving space, reducing setup and wiring time, and providing high efficiency and a highly stable system, the MH300 and MS300 are your key to improving market competitiveness and ensuring success.





Models Overview

Standard Models
High Speed Models
Exterior Design and Interfaces
Optional Cards

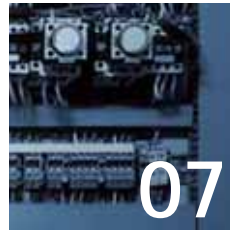

Optimized Space Utilization

Compact Design
Side-by-Side Installation



Outstanding Drive Performance

Supports IM and PM Motors
High Starting Torque
Enhanced Braking Capability
Fast Response to Load Changes
Deceleration Energy Backup (DEB)



Strong System Support

Multi-motor Control
Pulse Control
Built-in PLC
High Speed Applications
24 V_{DC} Power Supply
High Overload Capability
Built-in Brake Chopper
Closed Loop Control
Supports Various Communications



Stable, Safe and Reliable

Safety Standards Compliance
Enhanced Conformal Coating
Built-in EMC Filter
IP40 Models



Easy to Install

Application Parameter Settings
Built-in USB port
Screwless Wiring of Control Terminal



Wide Range of Applications

Machine Tools
Woodworking Machines
Automatic Tool Changers (ATC)
Water Pumps
Packaging Machines
Textile Machines



Specifications

Product Specifications
Wiring
Dimensions
Accessories
Model Name Explanation
Ordering Information

Models Overview



Standard Models

115V single-phase

Applicable Motor Output (kW)	0.2	0.4	0.75
Applicable Motor Output (HP)	0.25	0.5	1
Frame Size	A		C

230V single-phase

Applicable Motor Output (kW)	0.2	0.4	0.75	1.5	2.2
Applicable Motor Output (HP)	0.25	0.5	1	2	3
Frame Size	A		B	C	

230V single-phase (Built-in EMC filter)

Applicable Motor Output (kW)	0.2	0.4	0.75	1.5	2.2
Applicable Motor Output (HP)	0.25	0.5	1	2	3
Frame Size	B			C	

230V 3-phase

Applicable Motor Output (kW)	0.2	0.4	0.75	1.5	2.2	3.7/4	5.5	7.5	11	15
Applicable Motor Output (HP)	0.25	0.5	1	2	3	5	7.5	10	15	20
Frame Size	A			B	C		D	E		F

460V 3-phase

Applicable Motor Output (kW)	0.4	0.75	1.5	2.2	3.7/4	5.5	7.5	11	15	18.5	22
Applicable Motor Output (HP)	0.5	1	2	3	5	7.5	10	15	20	25	30
Frame Size	A		B	C		D		E		F	

460V 3-phase (Built-in EMC filter)

Applicable Motor Output (kW)	0.4	0.75	1.5	2.2	3.7/4	5.5	7.5	11	15	18.5	22
Applicable Motor Output (HP)	0.5	1	2	3	5	7.5	10	15	20	25	30
Frame Size	B			C		D		E		F	

High Speed Models

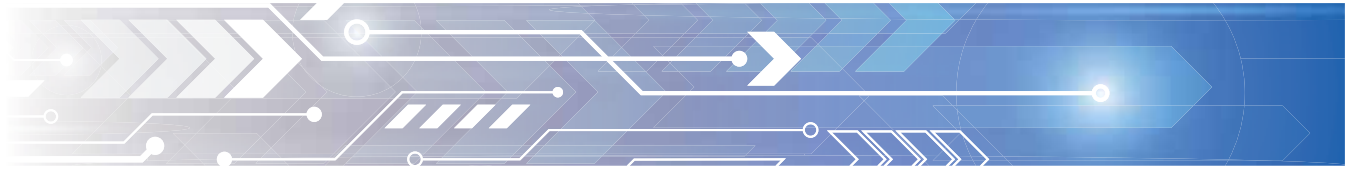

230V single-phase

Applicable Motor Output (kW)	1.5	2.2
Applicable Motor Output (HP)	2	3
Frame Size	C	

230V single-phase (Built-in EMC filter)

Applicable Motor Output (kW)	1.5	2.2
Applicable Motor Output (HP)	2	3
Frame Size	C	

230V 3-phase

Applicable Motor Output (kW)	1.5	2.2	3.7/4	5.5	7.5	11	15
Applicable Motor Output (HP)	2	3	5	7.5	10	15	20
Frame Size	B	C		D	E		F

460V 3-phase

Applicable Motor Output (kW)	1.5	2.2	3.7/4	5.5	7.5	11	15	18.5	22
Applicable Motor Output (HP)	2	3	5	7.5	10	15	20	25	30
Frame Size	B	C		D		E		F	

460V 3-phase (Built-in EMC filter)

Applicable Motor Output (kW)	1.5	2.2	3.7/4	5.5	7.5	11	15	18.5	22
Applicable Motor Output (HP)	2	3	5	7.5	10	15	20	25	30
Frame Size	B	C		D		E		F	

Models Overview



Hardware Design

Compact design and user-friendly interface

Removable Keypad

Press to remove; for remote operation away from drive



Built-in USB Port

Easy and fast programming setting, update and real-time monitoring and tuning



Specified Product Label

Input/output current, voltage and protection rating

Screwless Top Cover Design

Press on both side tabs to remove the cover



Removable Fan

Easy to replace and maintain for a longer lifetime



MH300 Series
5 digits 16 segments LCD display, quick setting wheel dial, left-shift function key



MS300 Series
5 digits 7 segments LED display, frequency knob, Up and Left/Down function keys

Removable RFI Jumper

Applicable for different application needs



Option Cards

A wide selection of option cards for highly flexible applications

PG Cards (for MH300)

<p>ABZ Signal Line driver</p> 	<p>ABZ Signal Open collector</p> 
<p>Resolver PM motors</p> 	

I/O Cards (for MH300)

<p>I/O</p> 	<p>Analog</p> 
--	---

Relay Cards (for MH300)







<p>Form A *3</p> 	<p>Form C *2</p> 
--	--



External Power Supply Card (DC 24V)



Communication Cards

<p>CANopen*</p>  <p>* For MS300 only</p>	<p>DeviceNet</p> 
<p>PROFIBUS DP</p> 	<p>EtherNet/IP</p> 
<p>MODBUS TCP</p> 	<p>EtherCAT*</p>  <p>* For MH300 only</p>

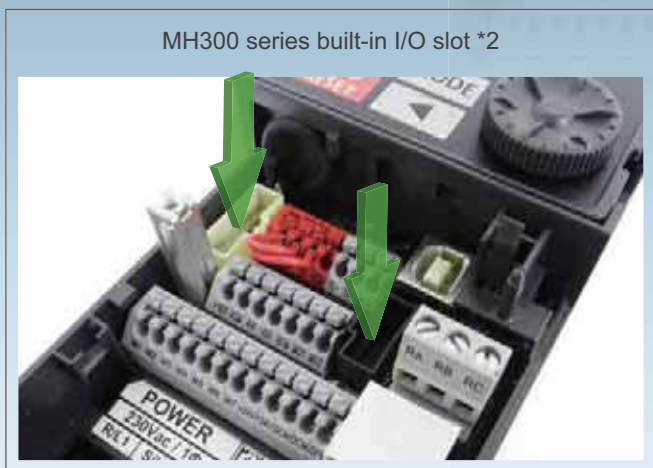

Optimized Space Utilization

Compact Design

Provides more powerful features in smaller sizes with reduction up to 40% that effectively optimizes the installation space.

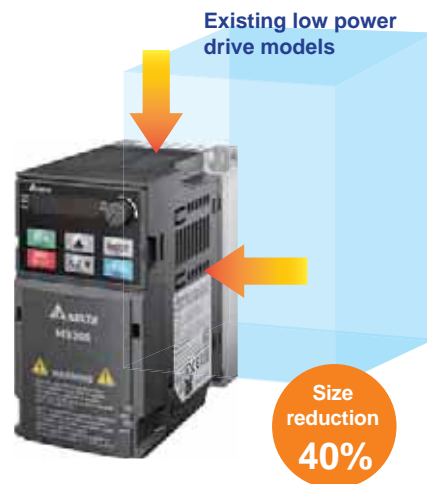

Side-by-Side Installation

Supports side-by-side installation with operating temperatures of $-20^{\circ}\text{C} \sim 40^{\circ}\text{C}$. Enables highly flexible and highly efficient installation.

Substantial savings in space!



Outstanding Drive Performance



Supports IM and PM Motors

MS300: Supports 4 independent induction motor control parameter sets.

MH300: Supports 8 independent induction motor control parameter sets.

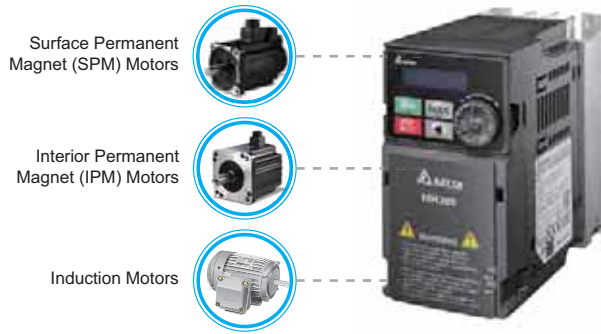

High Starting Torque

Delivers 200% high starting torque with a low speed control of 0.5Hz. This feature provides outstanding machine stability and is suitable for dynamic loading applications.

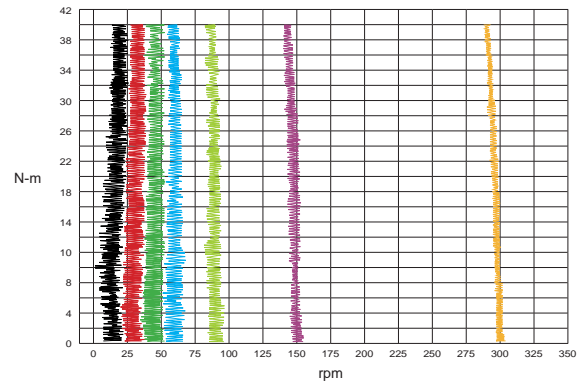

Enhanced Braking Capability

Provides Deceleration Energy Control Mode to shorten braking time by adjusting the motor speed and current. This feature replaces the need for braking resistors.

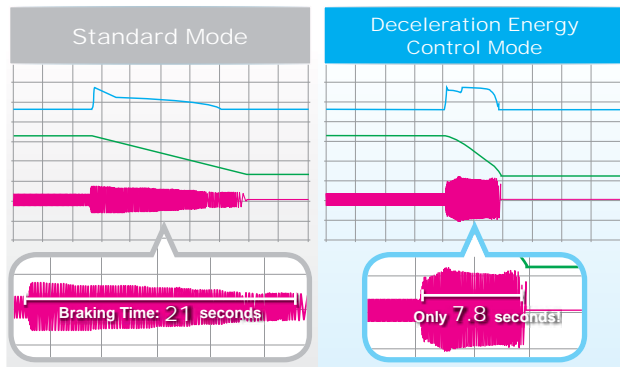

* Actual deceleration performance would depend on different system loads

Fast Response to Load Impact

Fast response to sudden load impact on speeds to ensure stable operation and high quality output.

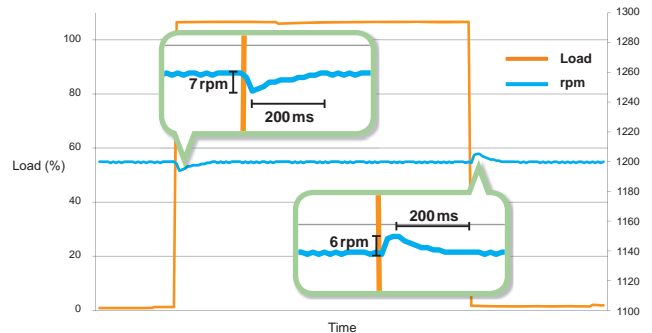

Deceleration Energy Backup (DEB)

Controls the motor deceleration to a stop when an unexpected power shut-down occurs to prevent mechanical damage. When power resumes, the motor will accelerate to its previous speed.

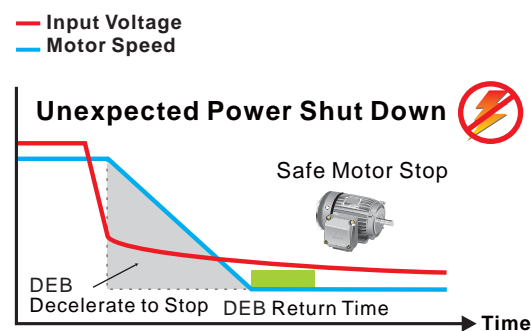
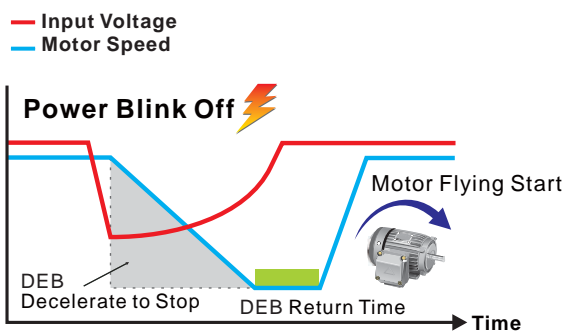

Strong System Support

Multi-motor Control

MH300 series supports 8 induction motors switching control.

MS300 series supports 4 induction motors switching control.

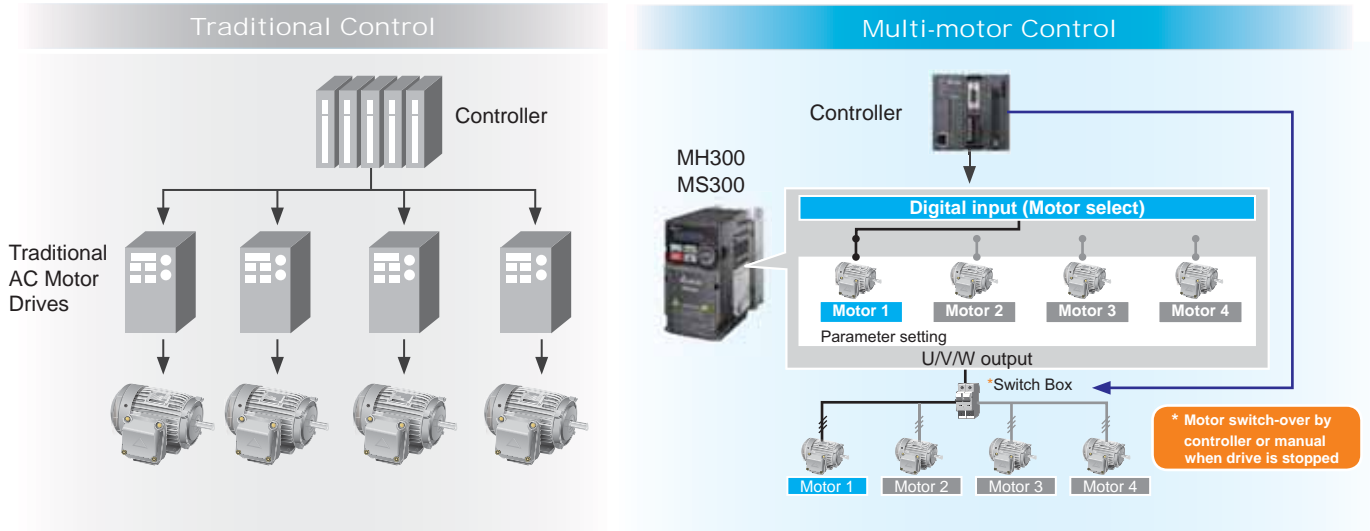

Pulse Input

MH300

Supports a dual pulse input signal from controller or a feedback signal from encoder without an additional PG card to achieve simple closed-loop control. Terminal MI7 supports single pulse signal input as a frequency command.

MS300

Supports single pulse input signal from controller as frequency setting.

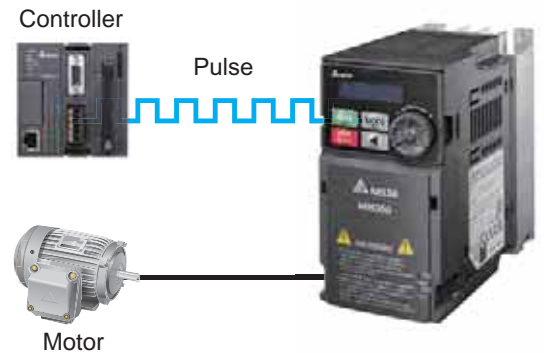

Built-in PLC

MH300 built-in PLC capacity (5k steps) and MS300 built-in PLC capacity (2k steps) to provide distributed control and independent operation via network connection.

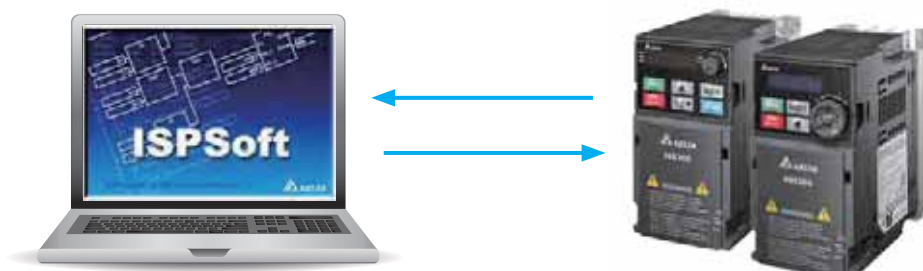

High-Speed Applications

High-speed models are available in both MH300 and MS300 series to support high-speed processing.

MH300

Type	Model	Frequency Setting
Standard	VFD □□□ MH □□□□ SAA	0 ~ 599Hz
High-speed	VFD □□□ MH □□□□ SHA	0 ~ 2000Hz

MS300

Type	Model	Frequency Setting
Standard	VFD □□□ MS □□□□ SAA	0 ~ 599Hz
High-speed	VFD □□□ MS □□□□ SHA	0 ~ 1500Hz

High Overload Capability

- Normal duty: rated current 120% for 60 seconds; 150% for 3 seconds
- Heavy duty: rated current 150% for 60 seconds; 200% for 3 seconds

Built-in Braking Chopper

Larger braking torque capability is provided by using an additional braking resistor.

Versatile Communication Interfaces

- MH300, built-in RS-485 (MODBUS) and CANopen
- MS300, built-in RS-485 (MODBUS)

More communication cards are available upon selection.

DC 24V External Power

External power supply is available when main power failure occurs to ensure uninterrupted communication and to protect the system.

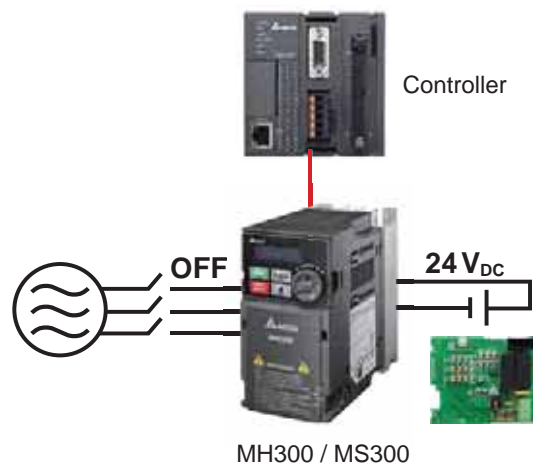

Closed-Loop Control

Optional PG card is available for MH300 to support closed-loop control function and providing higher precision of motor speed control.

PG card installation (front side down)

No influence to drive size; suitable for all space restricted applications



PG card installation (front side up)

Increases the drive size in depth



Communication	MH300	MS300
MODBUS	Built-in	Built-in
PROFIBUS DP	Optional	Optional
DeviceNet	Optional	Optional
MODBUS TCP	Optional	Optional
EtherNet/IP	Optional	Optional
CANopen	Built-in	Optional
EtherCAT	Optional	(To be announced)

Stable, Safe and Reliable



Safety Standard

Integrated Safe Torque Off (STO), compliance with:

- ▶ EN ISO 13849-1 Cat3/PLd
- ▶ EN 61508 SIL2
- ▶ EN 60204-1 Category 0
- ▶ EN 62061 SIL CL 2

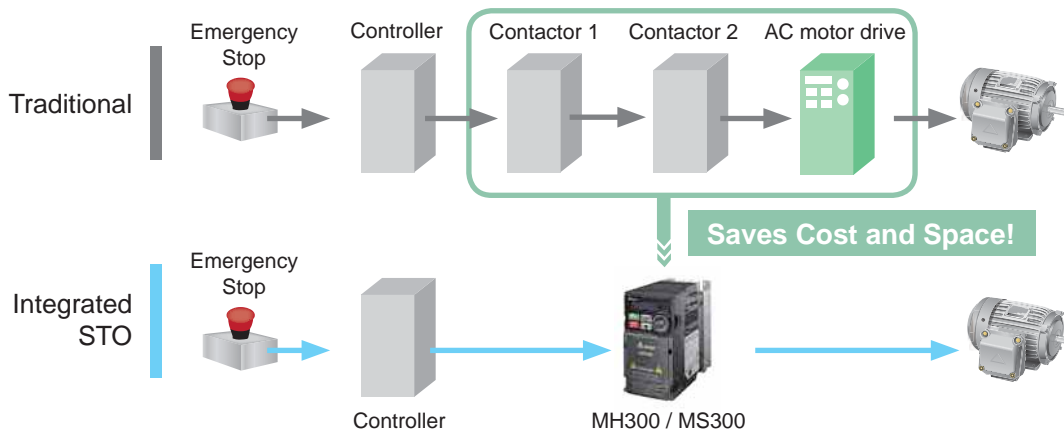

PCB Coating

100% PCB coating (IEC 60721-3-3 class 3C2 standard) ensures drive operation stability and safety in critical environments.

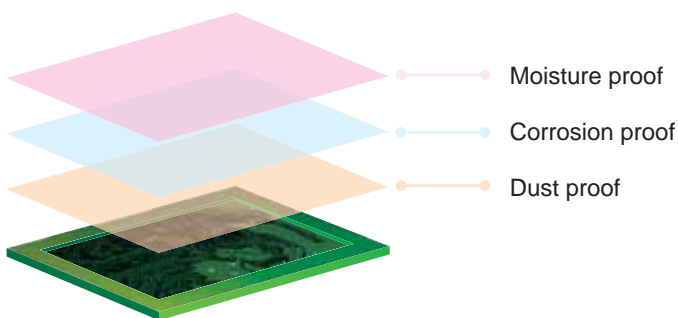

IP 40 Models

Strengthened fan coating and concealed air vent prevent dust and other particles from entering the drive, suitable for critical environment applications.



Built-in EMC Filter

Built-in Class A (C2) standard EMC filter; saves on additional procurement cost and wiring time, and provides more cabinet space for other devices to use.

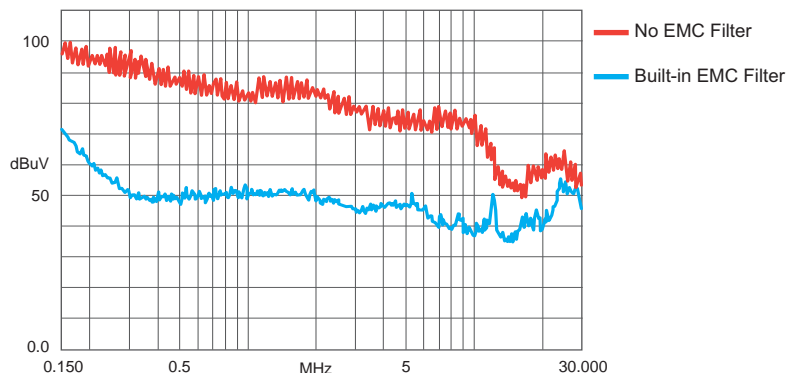

Easy to Install

Application Groups (Macro)

Simplifies the parameter setting process by grouping the parameters for different applications to use.

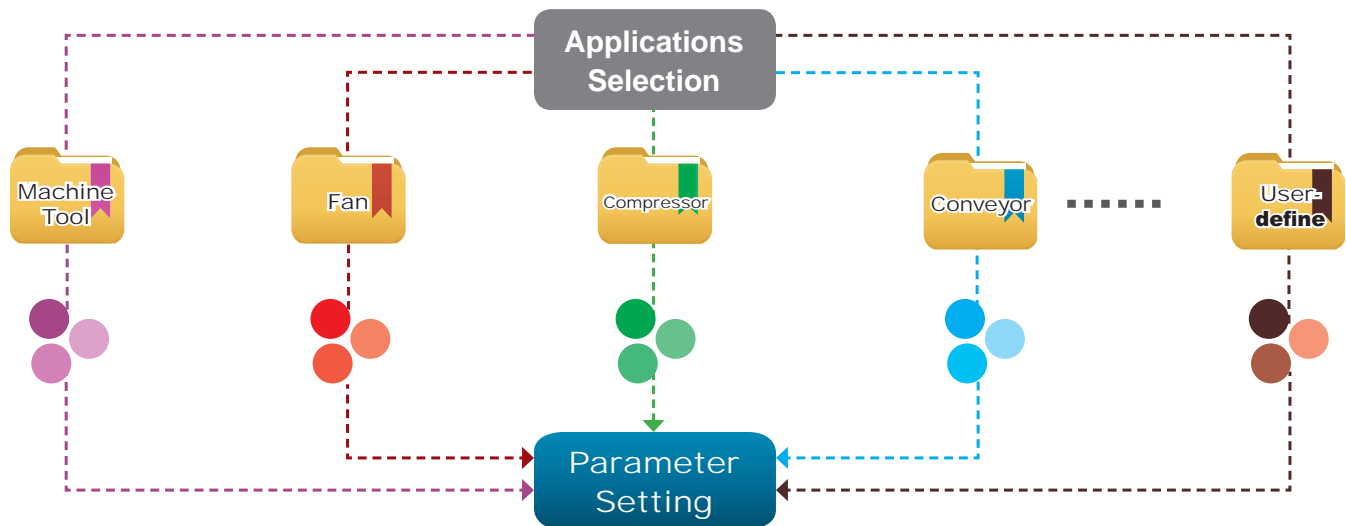

Built-in USB Port

Built-in USB port facilitates the drive setting, updating, real-time monitoring and system tuning process.

- No need of USB or RS-485 connectors
- Supports offline (drive power off) parameter setting/copying and system update

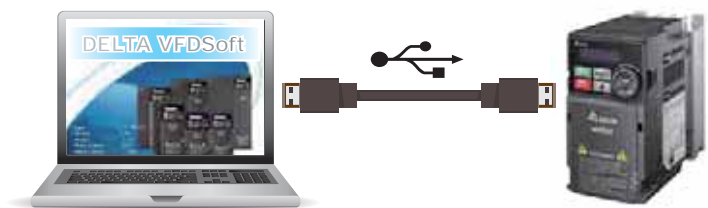

Screwless Wiring of Control Terminal

Spring clamp terminal blocks provide fast and easy wiring

Saves wiring time

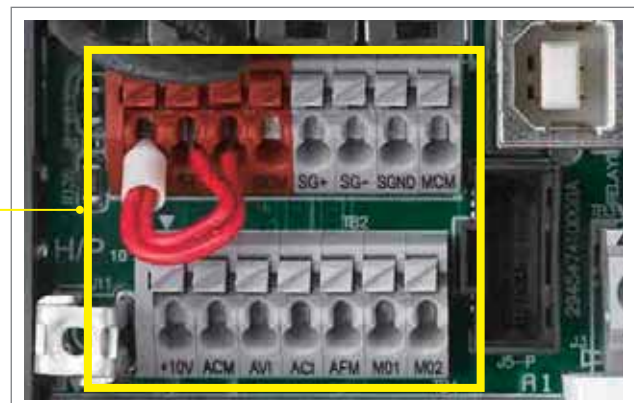

Wide Range of Applications



Machine Tools

Features and Benefits

- High-speed models support main spindle 2000Hz/1500Hz frequency output; and is suitable for complex and high precision processing applications
- Timely acceleration/deceleration control to improve machinery operation efficiency
- Built-in braking chopper to save on purchasing cost
- Built-in PLC capacity for flexible application needs
- Built-in STO function ensures operator safety and effectively reduces accident risk
- Provides deceleration to stop function to protect tools from damage and ensure operator safety

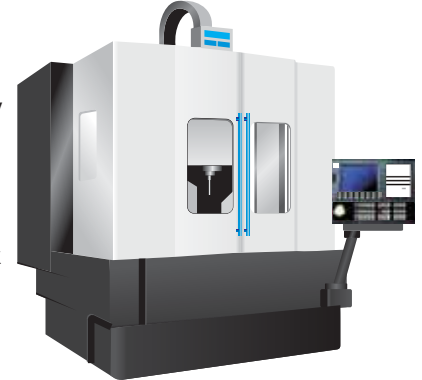

Woodworking Machines

Features and Benefits

- Timely acceleration/deceleration control, improves machinery operation efficiency
- Built-in STO function ensures operator safety and effectively reduces accident risk
- Built-in PLC capacity saves on purchasing cost
- Built-in EMC filter effectively reduces electromagnetic interference
- Compact in size and weight, easy to install and maintain

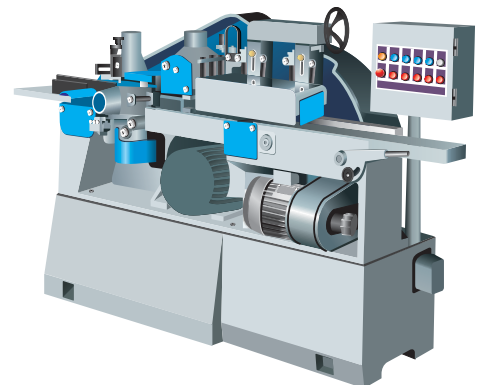

Automatic Tool Changers (ATC)

Features and Benefits

- Compact design of drive provides more cabinet space for other devices to use
- Quick start and timely acceleration/deceleration control function effectively shortens tool changing time and improves system efficiency and productivity
- Simple structure is easy to install and maintain
- Built-in STO function ensures operator safety and effectively reduces accident risk
- Built-in braking chopper saves on purchasing cost

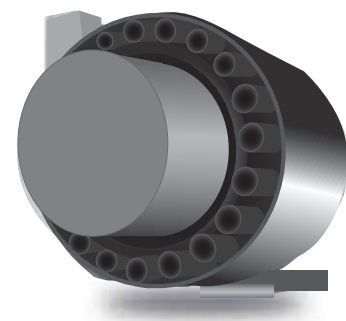

Pumps Application

Features and Benefits

- Built-in PID feedback control
- Built-in PLC capacity saves on purchasing cost of PLC and relay
- Supports a wide range of input voltages which are suitable for various types of pumps application and use in different countries
- Deceleration energy control mode shortens deceleration time and reduces braking resistor cost, also provides more space for other devices to use

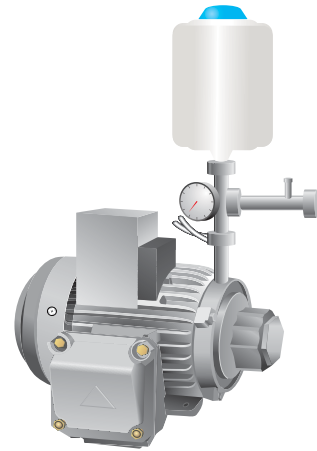

Packaging Machines

Features and Benefits

- Compact design of drive provides more cabinet space for other devices to use
- Built-in STO function ensures operator safety and effectively reduces accident rate
- Built-in braking chopper saves on system construction cost
- Built-in RS-485 (MODBUS) and various communication cards upon selection (optional)
- High-speed pulse input
- Supports frequency command by pulse input to improve control precision.
- Precise and stable tension control provides high flexibility in using different packaging materials

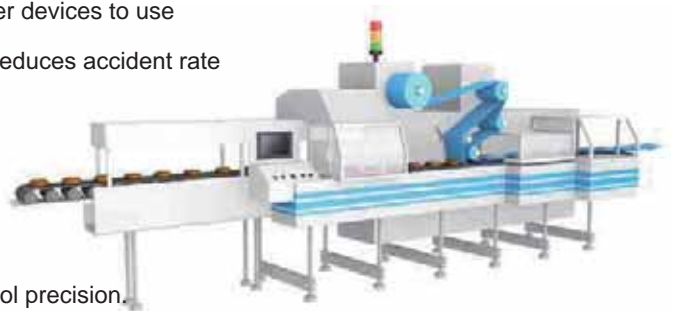

Textile Machines

Features and Benefits

- IP40 models provide excellent protection from a high dust, fiber or moisture environment
- Improved heatsink design prevents fiber clogging the air way; modular design of fan is easy to clean and provides longer lifetime
- Improved braking capability shortens the deceleration to stop time and is suitable for sudden stop requirements
- Built-in STO function ensures operator safety and effectively reduces accident rate
- Supports both induction motors and PM motors
- Provides deceleration to stop function to protect the equipment from damage when sudden power failure occurs



Specifications

MH300 Product Specifications

single-phase
115 V

Frame			Models without built-in EMC filter		
Frame			A		C
Applicable Motor Output (kW)			0.2	0.4	0.75
Applicable Motor Output (HP)			1/4	1/2	1
Inverter Output	Heavy Duty	Rated Output Current (A)	1.6	2.5	5
	Normal Duty	Rated Output Current (A)	1.8	2.7	5.5
Carrier Frequency (kHz)			2 ~ 15kHz (default 4kHz)		
Brake Chopper			Built-in		
DC Reactor			Optional		
AC Reactor			Optional		
Cooling Method			Natural air cooling		Fan cooling
Size: W×H (mm)			68×128		87×157
Size: D (mm)			115	129	152

single-phase
230 V

Frame			Models with built-in EMC filter				
Frame			B		C		
Applicable Motor Output (kW)			0.2	0.4	0.75	1.5	2.2
Applicable Motor Output (HP)			1/4	1/2	1	2	3
Inverter Output	Heavy Duty	Rated Output Current (A)	1.6	2.8	5	7.5	11
	Normal Duty	Rated Output Current (A)	1.8	3.2	5.2	8.5	12.5
Carrier Frequency (kHz)			2 ~ 15kHz (default 4kHz)				
Brake Chopper			Built-in				
DC Reactor			Optional				
AC Reactor			Optional				
Cooling Method			Natural air cooling	Fan cooling			
Size: W×H (mm)			72×142			87×157	
Size: D (mm)			159			179	
Frame			Models without an EMC filter				
Frame			A	B	C		
Cooling Method			Natural air cooling			Fan cooling	
Size: W×H (mm)			68×128	68×128	72×142	87×157	
Size: D (mm)			115	129	147	152	

MH300 Product Specifications

3-phase
230 V

Models without built-in EMC filter													
Frame			A		B	C		D	E		F		
Applicable Motor Output (kW)			0.2	0.4	0.75	0.75	1.5	2.2	3.7/4	5.5	7.5	11	15
Applicable Motor Output (HP)			1/4	1/2	1	1	2	3	5	7.5	10	15	20
Inverter Output	Heavy Duty	Rated Output Current (A)	1.6	2.8	5	5	7.5	11	17	25	33	49	65
	Normal Duty	Rated Output Current (A)	1.8	3.2	5.2	5.2	8	12.5	19.5	27	36	51	69
Carrier Frequency (kHz)			2 ~ 15 kHz (default 4 kHz)										
Brake Chopper			Built-in										
DC Reactor			Optional										
AC Reactor			Optional										
Cooling Method			Natural air cooling				Fan cooling						
Size: W×H (mm)			68×128			72×142	87×157	109×207	130×250	175×300			
Size: D (mm)			129	129	147	135	143	152	154	185	192		

3-phase
460 V

Models with built-in EMC filter														
Frame			B		C		D		E		F			
Applicable Motor Output (kW)			0.4	0.75	0.75	1.5	2.2	3.7/4	5.5	7.5	11	15	18.5	22
Applicable Motor Output (HP)			1/2	1	1	2	3	5	7.5	10	15	20	25	30
Inverter Output	Heavy Duty	Rated Output Current (A)	1.5	3	3	4.2	5.7	9	13	17.5	25	32	38	45
	Normal Duty	Rated Output Current (A)	1.8	3.3	3.3	4.6	6.5	10.5	14.5	19.8	28	36	41.5	49
Carrier Frequency (kHz)			2 ~ 15 kHz (default 4 kHz)											
Brake Chopper			Built-in											
DC Reactor			Optional											
AC Reactor			Optional											
Cooling Method			Fan cooling											
Size: W×H (mm)			72×142				87×157	109×207	130×250	175×300				
Size: D (mm)			159				179	187	219	244				
Models without an EMC filter														
Frame			A		B	C		D	E		F			
Cooling Method			Natural air cooling		Fan cooling									
Size: W×H (mm)			68×128			72×142	87×157	109×207	130×250	175×300				
Size: D (mm)			129	147	135	143	152	154	185	192				

MS300 Product Specifications

Single-phase
115 V

			Models without built-in EMC filter		
Frame			A		C
Applicable Motor Output (kW)			0.2	0.4	0.75
Applicable Motor Output (HP)			1/4	1/2	1
Inverter Output	Heavy Duty	Rated Output Current (A)	1.6	2.5	4.8
	Normal Duty	Rated Output Current (A)	1.8	2.7	5.5
Carrier Frequency (kHz)			2 ~ 15kHz (default 4kHz)		
Brake Chopper			Built-in		
DC Reactor			Optional		
AC Reactor			Optional		
Cooling Method			Natural air cooling		Fan cooling
Size: W×H (mm)			68×128		87×157
Size: D (mm)			96	125	152

Single-phase
230 V

			Models with built-in EMC filter				
Frame			B		C		
Applicable Motor Output (kW)			0.2	0.4	0.75	1.5	2.2
Applicable Motor Output (HP)			1/4	1/2	1	2	3
Inverter Output	Heavy Duty	Rated Output Current (A)	1.6	2.8	4.8	7.5	11
	Normal Duty	Rated Output Current (A)	1.8	3.2	5	8.5	12.5
Carrier Frequency (kHz)			2 ~ 15kHz (default 4kHz)				
Brake Chopper			Built-in				
DC Reactor			Optional				
AC Reactor			Optional				
Cooling Method			Natural air cooling	Fan cooling			
Size: WxH (mm)			72x142			87x157	
Size: D (mm)			159			179	
			Models without an EMC filter				
Frame			A	B	C		
Cooling Method			Natural air cooling			Fan cooling	
Size: W×H (mm)			68×128	68×128	72×142	87×157	
Size: D (mm)			96	125	143	152	

MS300 Product Specifications

3-phase
230 V

Models without built-in EMC filter													
Frame			A			B	C		D		E		F
Applicable Motor Output (kW)			0.2	0.4	0.75	1.5	2.2	3.7/4	5.5	7.5	11	15	
Applicable Motor Output (HP)			1/4	1/2	1	2	3	5	7.5	10	15	20	
Inverter Output	Heavy Duty	Rated Output Current (A)	1.6	2.8	4.8	7.5	11	17	25	33	49	65	
	Normal Duty	Rated Output Current (A)	1.8	3.2	5	8	12.5	19.5	27	36	51	69	
Carrier Frequency (kHz)			2 ~ 15kHz (default 4kHz)										
Brake Chopper			Built-in										
DC Reactor			Optional										
AC Reactor			Optional										
Cooling Method			Natural air cooling				Fan cooling						
Size: W×H (mm)			68×128			72×142	87×157	109×207	130×250	175×300			
Size: D (mm)			96	110	143	143	152	154	185	192			

3-phase
460 V

Models with built-in EMC filter													
Frame			B			C		D		E		F	
Applicable Motor Output (kW)			0.4	0.75	1.5	2.2	3.7/4	5.5	7.5	11	15	18.5	22
Applicable Motor Output (HP)			1/2	1	2	3	5	7.5	10	15	20	25	30
Inverter Output	Heavy Duty	Rated Output Current (A)	1.5	2.7	4.2	5.5	9	13	17	25	32	38	45
	Normal Duty	Rated Output Current (A)	1.8	3	4.6	6.5	10.5	15.7	20.5	28	36	41.5	49
Carrier Frequency (kHz)			2 ~ 15kHz (default 4kHz)										
Brake Chopper			Built-in										
DC Reactor			Optional										
AC Reactor			Optional										
Cooling Method			Fan cooling										
Size: W×H (mm)			72×142			87×157	109×207	130×250	175×300				
Size: D (mm)			159			179	187	219	244				
Models without an EMC filter													
Frame			A		B	C		D		E		F	
Cooling Method			Natural air cooling			Fan cooling							
Size: W×H (mm)			68×128		72×142	87×157	109×207	130×250	175×300				
Size: D (mm)			129	143	143	152	154	185	192				

MH300 General Specifications and Accessories

Control Functions	Control Methods	V/f, SVC, VF+PG, FOC+PG, TQC+PG	
	Applicant Motors	Induction Motor (IM), Interior Permanent Magnet (IPM) Motor, Surface Permanent Magnet (SPM) Motor	
	Max. Output Frequency	Standard model: 599.00 Hz ; High speed model: 2000 Hz (with derating)	
	Starting Torque*	150%/3 Hz 200%/0.5 Hz 200%/0 Hz 100%/(1/20 of motor rated frequency) 150%/0 Hz 200%/0 Hz	(V/f, SVC, V/F+PG control for IM, Heavy duty) (FOC control for IM, Heavy duty) (FOC+PG control for IM, Heavy duty) (SVC control for PM, Heavy duty) (FOC control for PM, Heavy duty) (Closed loop vector control w/ PG for PM, Heavy duty)
	Speed Control Range*	1 : 50 (V/f, SVC, V/F+PG control for IM, Heavy duty) 1 : 100 (FOC control for IM, Heavy duty) 1 : 1000 (FOC+PG control for IM, Heavy duty)	1 : 20 (SVC control for PM, Heavy duty) 1 : 100 (FOC control for PM, Heavy duty) 1 : 1000 (Closed loop vector control w/ PG for PM, Heavy duty)
	Overload Tolerance	Normal Duty (ND): 120% of rated output current for 60 seconds; 150% of rated output current for 3 seconds Heavy Duty (HD): 150% of rated output current for 60 seconds; 200% of rated output current for 3 seconds	
	Frequency Setting Signal	0 ~ +10V / -10V ~ +10V, 4 ~ 20 mA / 0 ~ +10V, 2 Pulse input (33 kHz), 1 Pulse output (33 kHz)	
	Main Control Functions	Multiple motor switches (max. 8 independent motor parameter settings), Fast startup, Deceleration Energy Back (DEB) function, Wobble frequency function, Fast deceleration function, Master and Auxiliary frequency source selectable, Momentary power loss ride thru, Speed search, Over-torque detection, Torque limit, 16-step speed (max.), Accel/decel time switch, S-curve accel/decel, 3-wire sequence, JOG frequency, Upper/lower limits for frequency reference, DC injection braking at start and stop, PID control, Built-in PLC (5K steps), Positioning function, MODBUS and CANopen is integrated as standard	
Protection Functions	Motor Protection	Overcurrent protection, overvoltage protection, over-temperature protection, phase failure protection	
	Stall Prevention	Stall prevention during acceleration, deceleration and running independently	
Accessories	Communication cards	PROFIBUS DP, DeviceNet, MODBUS TCP, EtherNet/IP, EtherCAT	
	PG cards	EMM-PG01L (ABZ, Line driver) EMM-PG01O (ABZ, Open Collector)	EMM-PG01R (Resolver)
	I/O expansion cards	EMM-D33A (Digital Card - 3in 3out) EMM-A22A (Analog Card - 2in 2out)	EMM-R2CA (Relay Card) EMM-R3AA (Relay Card)
	External DC power supply	EMM-BPS01 (DC 24V power supply card)	
Digital Controller		A removable keypad as standard	
Certifications		UL, CE, RoHS, RCM, TUV, REACH	

*Control accuracy may vary depending on the environment, application conditions, different motors or encoder. For details, please contact our company or your local distributor.

MH300 / MS300 Operating Environment

Operating Environment	Installation Location	IEC60364-1/IEC60664-1 Pollution degree 2, Indoor use only		
	Ambient Temperature	Operation	IP20 / UL Open Type	-20 to 50 °C -20 to 60 °C (needs derating)
			IP40 / NEMA 1 / UL Type 1	-20 to 40 °C
			Zero stacking Installation	-20 to 50 °C (needs derating)
		Storage	-40 to 85 °C	
	Transportation	-20 to 70 °C		
		Rated Humidity	Operation	Max. 90%
	Storage / Transportation		Max. 95%	
	Air Pressure	Operation	86 ~ 106 kPa	
		Storage / Transportation	70 ~ 106 kPa	
Pollution Level	Compliance to IEC60721-3-3, 3C2			
Altitude	An altitude of 0 ~ 1000 m for normal operation (derating is required for installation at an altitude above 1000 m)			
Vibration		Compliance to IEC 60068-2-6		
Shock		Compliance to IEC/EN 60068-2-27		

Please refer to MH300/MS300 user manuals for more details.

MS300 General Specifications and Accessories

Control Functions	Control Methods	V/F, SVC
	Applicant Motors	Induction Motor (IM), Interior Permanent Magnet (IPM) Motor, Surface Permanent Magnet (SPM) Motor
	Max. Output Frequency	Standard model: 599.00Hz ; High speed model: 1500.0Hz (with derating, V/F control only)
	Starting Torque*	150%/3 Hz (V/f, SVC control for IM, Heavy duty) 100%/(1/20 of motor rated frequency) (SVC control for PM, Heavy duty)
	Speed Control Range*	1 : 50 (V/f, SVC control for IM, Heavy duty) 1 : 20 (SVC control for PM, Heavy duty)
	Overload Tolerance	Normal Duty (ND): 120% of rated output current for 60 seconds; 150% of rated output current for 3 seconds Heavy Duty (HD): 150% of rated output current for 60 seconds; 200% of rated output current for 3 seconds
	Frequency Setting Signal	0 ~ +10V/-10V ~ +10V, 4 ~ 20mA/0 ~ +10V, 1 Pulse input (33kHz), 1 Pulse output (33kHz)
Protection Functions	Main Control Functions	Multiple motor switches (max. 4 independent motor parameter settings), Fast run, Deceleration Energy Back (DEB) function, Wobble frequency function, Fast deceleration function, Master and Auxiliary frequency source selectable, Momentary power loss ride thru, Speed search, Over-torque detection, 16-step speed (max.), Accel/decel time switch, S-curve accel/decel, 3-wire sequence, JOG frequency, Upper/lower limits for frequency reference, DC injection braking at start and stop, PID control, Built-in PLC (2K steps), Simple positioning function, MODBUS is integrated as standard
	Motor Protection	Overcurrent protection, overvoltage protection, over-temperature protection, Phase failure protection
Accessories	Stall Prevention	Stall prevention during acceleration, deceleration and running independently
	Communication cards	PROFIBUS DP, DeviceNet, MODBUS TCP, EtherNet/IP, CANopen
Digital Controller	External DC power supply	EMM-BPS01 (DC 24V power supply card)
		A removable keypad as standard
Certifications		UL, CE, RoHS, RCM, TUV, REACH

*Control accuracy may vary depending on the environment, application conditions, different motors or encoder. For details, please contact our company or your local distributor.

Applications

MH300

Machine tools, textile machines, woodworking machines, rubber & plastic machines, cranes

MS300

Machine tools, textile machines, woodworking machines, packaging machines, electronics, fans, pumps, air compressors



MH300 Wiring

Input: Single-phase/ 3-phase power

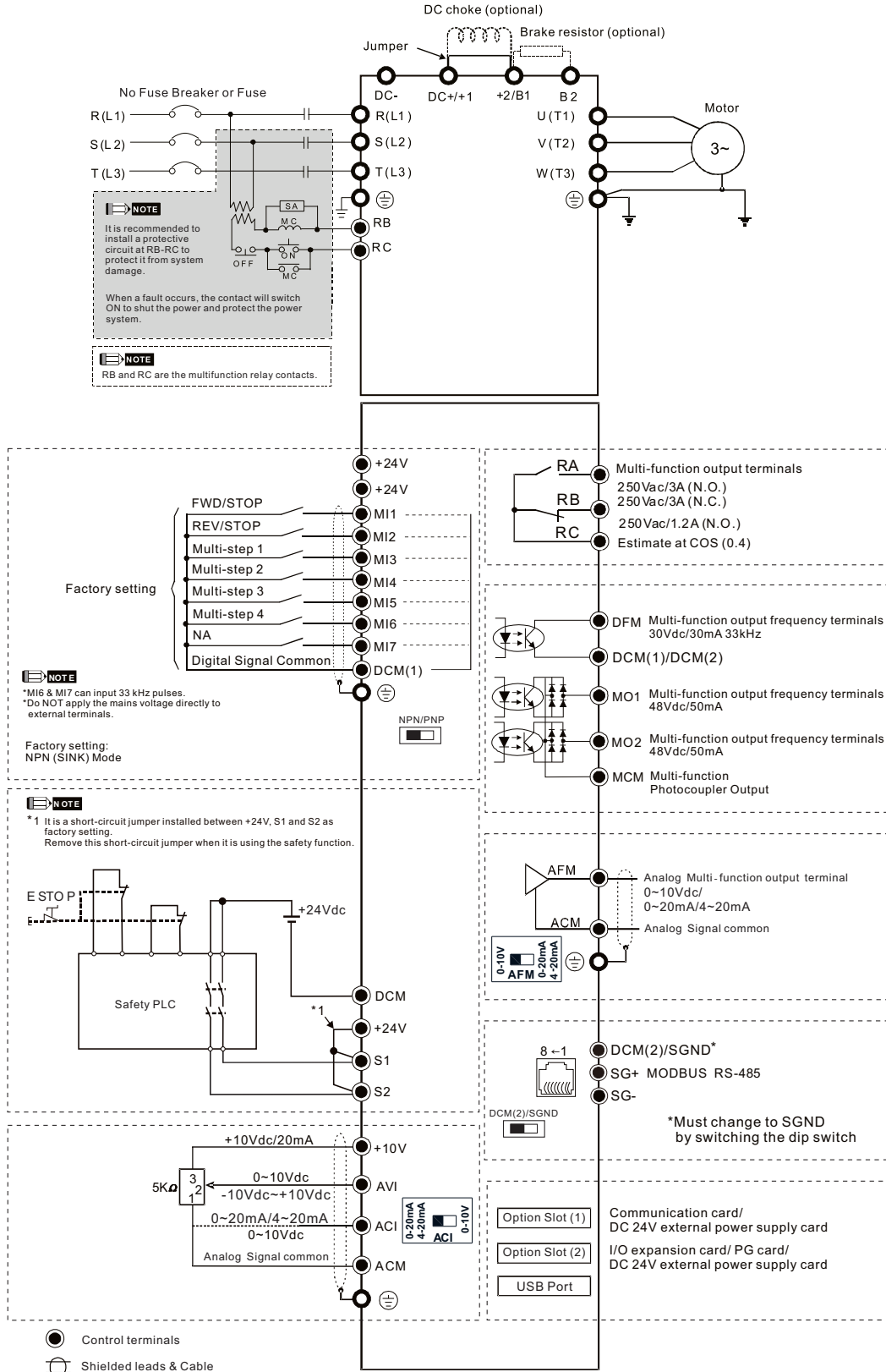

MS300 Wiring

Input: Single-phase/ 3-phase power

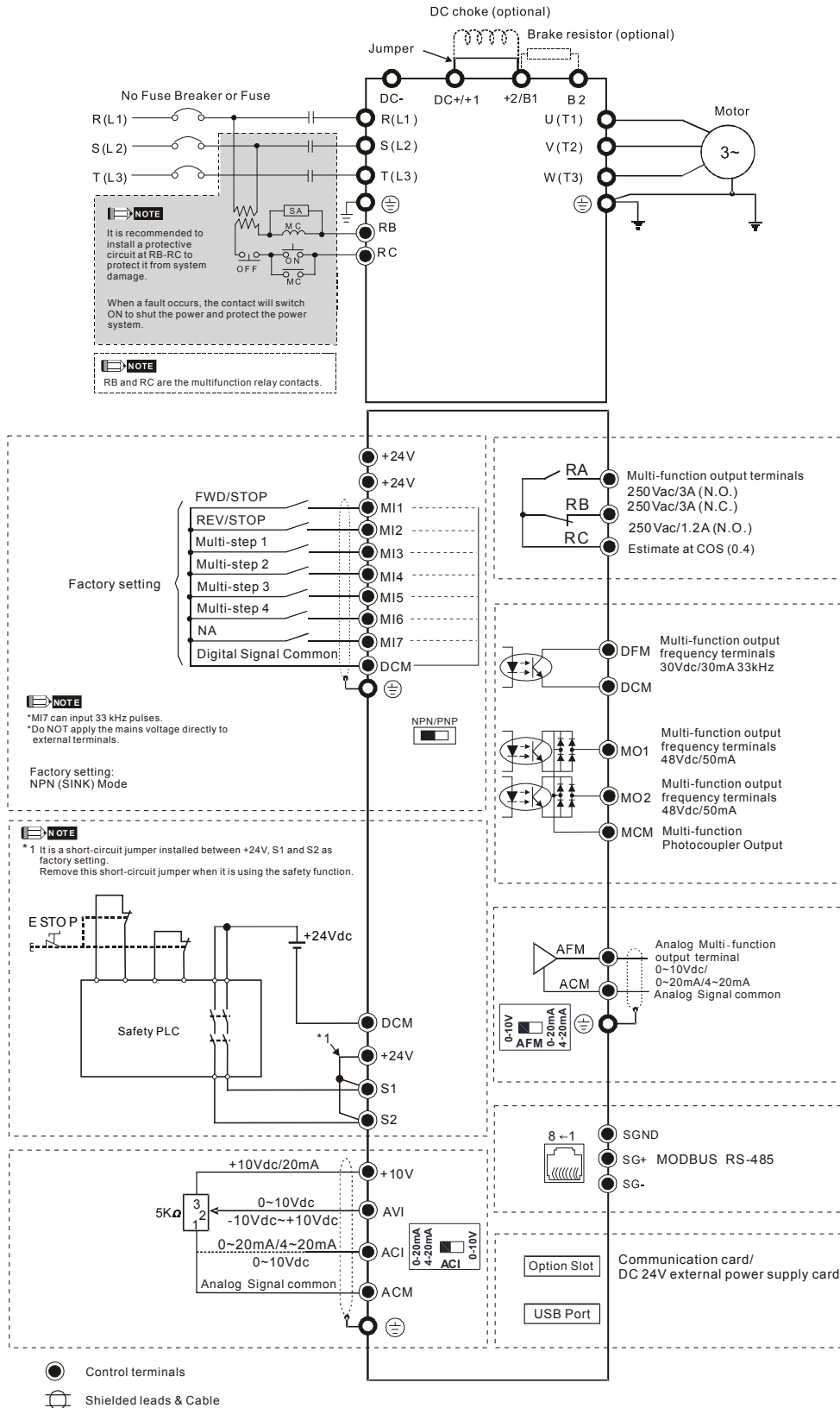

MH300 Dimensions

Frame A

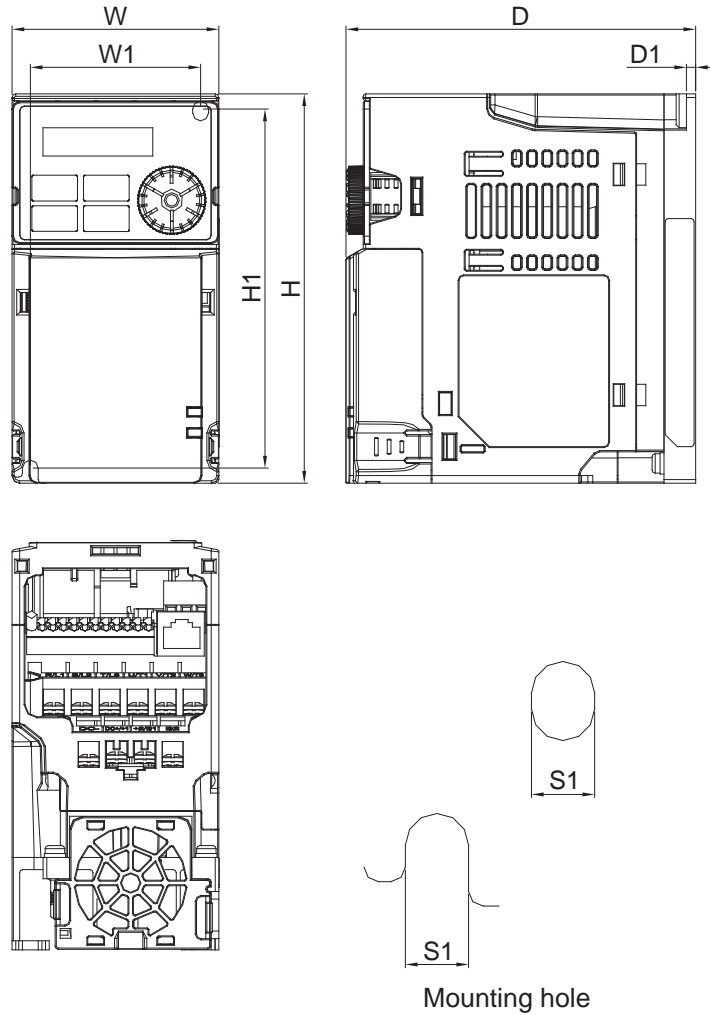

MODEL	FRAME A1	FRAME A2	FRAME A3	FRAME A4
VFD1A6MH11ANSAA	VFD2A5MH11ANSAA	VFD2A5MH11ENSAA	VFD5A0MH23ANSAA	VFD5A0MH23ANSNA
VFD1A6MH11ENSAA	VFD2A8MH21ANSAA	VFD2A8MH21ENSAA	VFD5A0MH23ENSAA	VFD5A0MH23ENSNA
VFD1A6MH21ANSAA	VFD1A6MH23ANSAA	VFD1A6MH23ENSAA	VFD3A0MH43ANSAA	VFD3A0MH43ANSNA
VFD1A6MH21ENSAA	VFD2A8MH23ANSAA	VFD2A8MH23ENSAA	VFD3A0MH43ENSAA	VFD3A0MH43ENSNA
	VFD1A5MH43ANSAA	VFD1A5MH43ENSAA		

Frame	W	H	D	W1	H1	D1	S1
A1	mm	68.0	128.0	115.0	56.0	118.0	3.0
	inch	2.68	5.04	4.53	2.20	4.65	0.12
A2	mm	68.0	128.0	129.0	56.0	118.0	3.0
	inch	2.68	5.04	5.08	2.20	4.65	0.12
A3	mm	68.0	128.0	135.0	56.0	118.0	3.0
	inch	2.68	5.04	5.31	2.20	4.65	0.12
A4	mm	68.0	128.0	147.0	56.0	118.0	3.0
	inch	2.68	5.04	5.79	2.20	4.65	0.12

Frame B

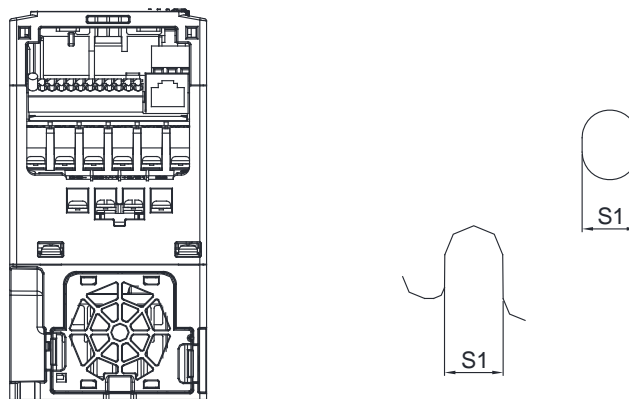
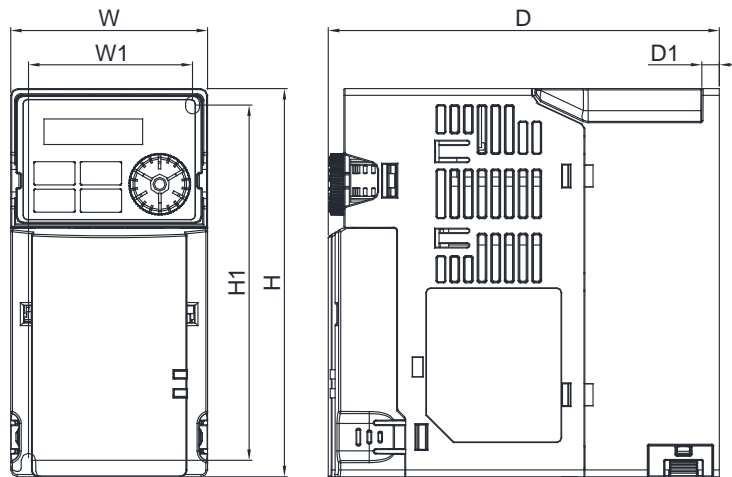

Mounting hole

MODEL	FRAME B1	FRAME B2	FRAME B3
Standard Models :	VFD7A5MH23ANSAA VFD7A5MH23ENSAA VFD4A2MH43ANSAA VFD4A2MH43ENSAA	Standard Models :	VFD5A0MH21ANSAA VFD5A0MH21ENSAA
High Speed Models :	VFD7A5MH23ANSHA VFD7A5MH23ENSHA VFD4A2MH43ANSHA VFD4A2MH43ENSHA	Standard Models :	VFD1A6MH21AFSAA VFD2A8MH21AFSAA VFD5A0MH21AFSAA VFD1A5MH43AFSAA VFD3A0MH43AFSAA VFD4A2MH43AFSAA
High Speed Models :	VFD4A2MH43AFSHA		

Frame		W	H	D	W1	H1	D1	S1
B1	mm	72.0	142.0	143.0	60.0	130.0	6.4	5.2
	inch	2.83	5.59	5.63	2.36	5.12	0.25	0.20
B2	mm	72.0	142.0	147.0	60.0	130.0	3.0	5.2
	inch	2.83	5.59	5.79	2.36	5.12	0.12	0.20
B3	mm	72.0	142.0	159.0	60.0	130.0	4.3	5.2
	inch	2.83	5.59	6.26	2.36	5.12	0.17	0.20

MH300 Dimensions

Frame C

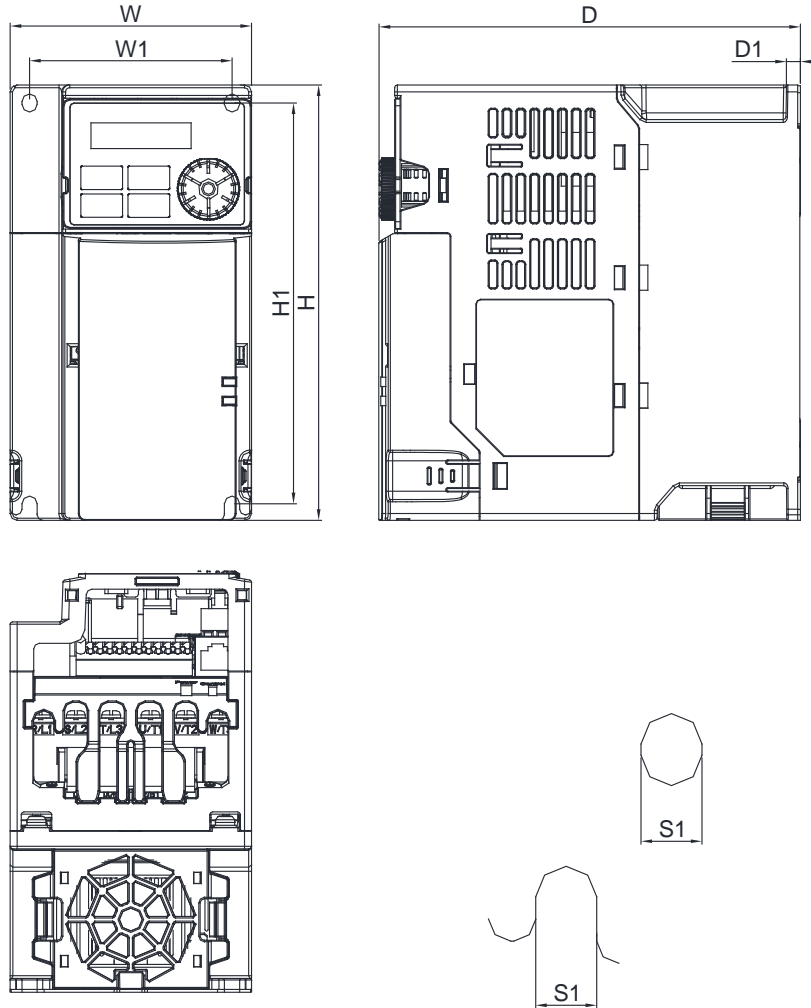

Mounting hole

MODEL FRAME C1

Standard Models :
 VFD5A0MH11ANSAA VFD5A0MH11ENSAA
 VFD7A5MH21ANSAA VFD7A5MH21ENSAA
 VFD11AMH21ANSAA VFD11AMH21ENSAA
 VFD11AMH23ANSAA VFD11AMH23ENSAA
 VFD17AMH23ANSAA VFD17AMH23ENSAA
 VFD5A7MH43ANSAA VFD5A7MH43ENSAA
 VFD9A0MH43ANSAA VFD9A0MH43ENSAA

High Speed Models :
 VFD7A5MH21ANSHA VFD7A5MH21ENSHA
 VFD11AMH21ANSHA VFD11AMH21ENSHA
 VFD11AMH23ANSHA VFD11AMH23ENSHA
 VFD17AMH23ANSHA VFD17AMH23ENSHA
 VFD5A7MH43ANSHA VFD5A7MH43ENSHA
 VFD9A0MH43ANSHA VFD9A0MH43ENSHA

FRAME C2

Standard Models :
 VFD7A5MH21AFSAA VFD7A5MH21AFSHA
 VFD11AMH21AFSAA VFD11AMH21AFSHA
 VFD5A7MH43AFSAA VFD5A7MH43AFSHA
 VFD9A0MH43AFSAA VFD9A0MH43AFSHA

Frame		W	H	D	W1	H1	D1	S1
C1	mm	87.0	157.0	152.0	73.0	144.5	5.0	5.5
	inch	3.43	6.18	5.98	2.87	5.69	0.20	0.22
Frame		W	H	D	W1	H1	D1	S1
C2	mm	87.0	157.0	179.0	73.0	144.5	5.0	5.5
	inch	3.43	6.18	7.05	2.87	5.69	0.20	0.22

Frame D

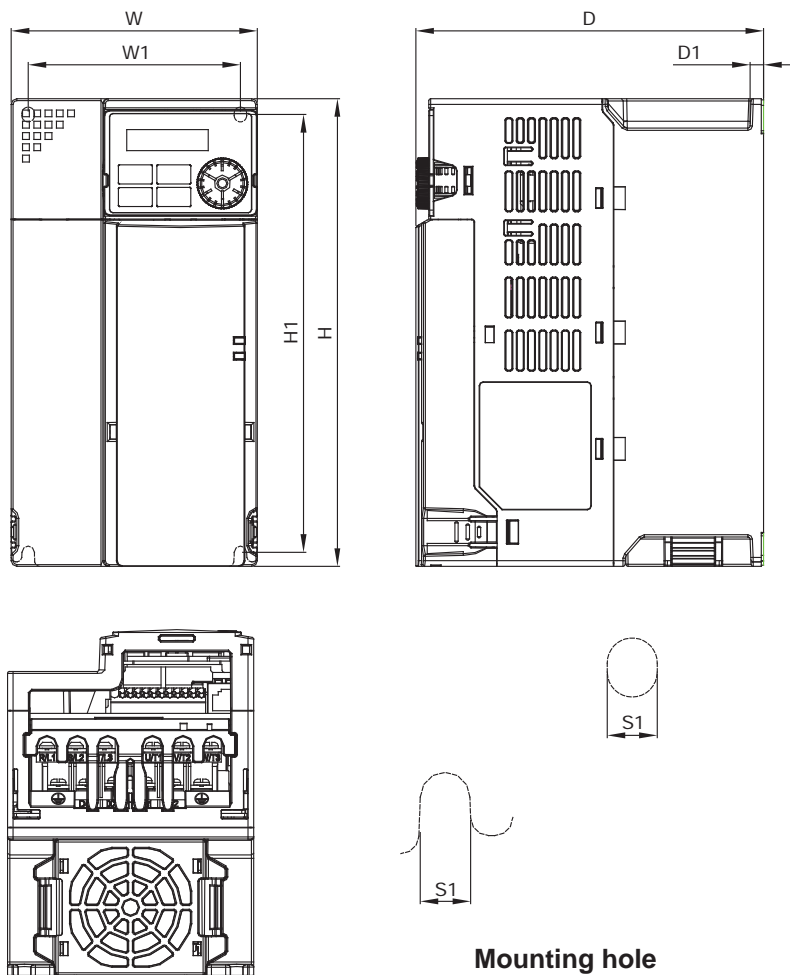

MODEL FRAME D1

Standard Models :
 VFD25AMH23ANSAA
 VFD25AMH23ENSAA
 VFD13AMH43ANSAA
 VFD13AMH43ENSAA
 VFD17AMH43ANSAA
 VFD17AMH43ENSAA

High Speed Models :
 VFD25AMH23ANSHA
 VFD25AMH23ENSHA
 VFD13AMH43ANSHA
 VFD13AMH43ENSHA
 VFD17AMH43ANSHA
 VFD17AMH43ENSHA

FRAME D2

Standard Models :
 VFD13AMH43AFSAA
 VFD17AMH43AFSAA

High Speed Models :
 VFD13AMH43AFSHA
 VFD17AMH43AFSHA

Frame		W	H	D	W1	H1	D1	S1
D1	mm	109.0	207.0	154.0	94.0	193.8	6.0	5.5
	inch	4.29	8.15	6.06	3.70	7.63	0.24	0.22
Frame		W	H	D	W1	H1	D1	S1
D2	mm	109.0	207.0	187.0	94.0	193.8	6.0	5.5
	inch	4.29	8.15	7.36	3.70	7.63	0.24	0.22

MH300 Dimensions

Frame E

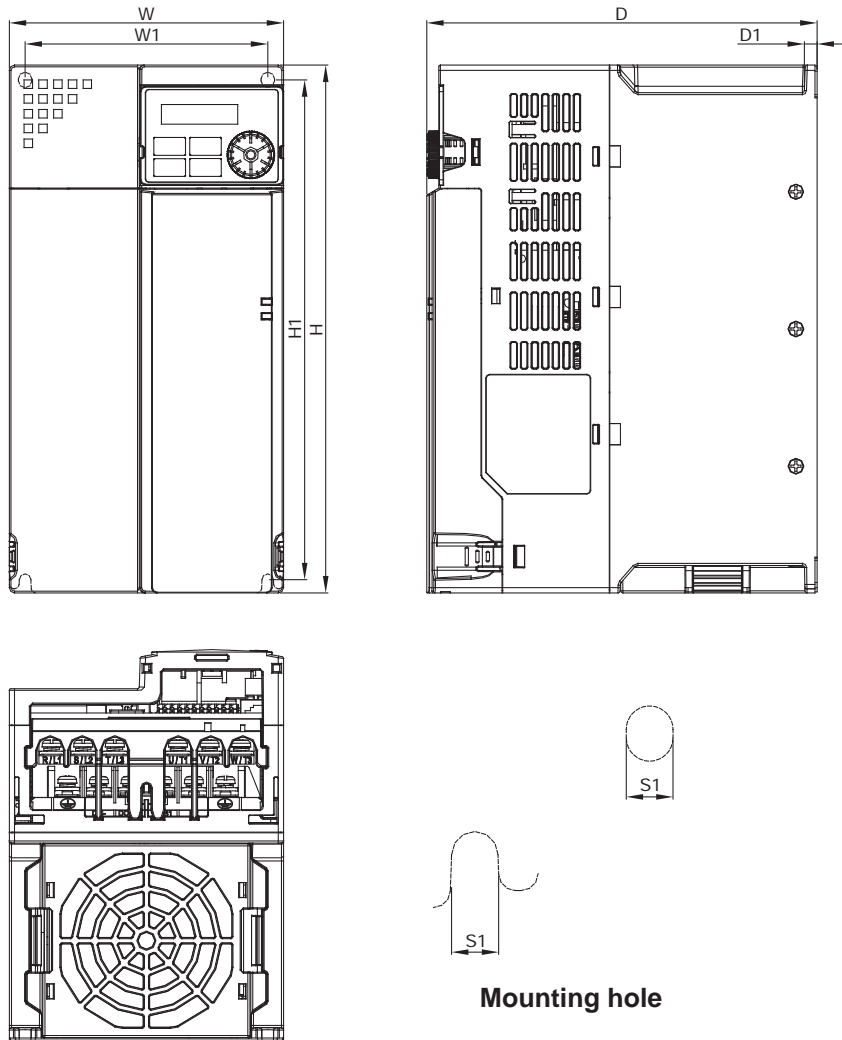

Mounting hole

MODEL FRAME E1

Standard Models :
 VFD33AMH23ANSAA
 VFD33AMH23ENSAA
 VFD49AMH23ANSAA
 VFD49AMH23ENSAA
 VFD25AMH43ANSAA
 VFD25AMH43ENSAA
 VFD32AMH43ANSAA
 VFD32AMH43ENSAA

High Speed Models :
 VFD33AMH23ANSHA
 VFD33AMH23ENSHA
 VFD49AMH23ANSHA
 VFD49AMH23ENSHA
 VFD25AMH43ANSHA
 VFD25AMH43ENSHA
 VFD32AMH43ANSHA
 VFD32AMH43ENSHA

FRAME E2

Standard Models :
 VFD25AMH43AFSAA
 VFD32AMH43AFSAA

High Speed Models :
 VFD25AMH43AFSHA
 VFD32AMH43AFSHA

Frame		W	H	D	W1	H1	D1	S1
E1	mm	130.0	250.0	185.0	115.0	236.8	6.0	5.5
	inch	5.12	9.84	7.83	4.53	9.32	0.24	0.22
Frame		W	H	D	W1	H1	D1	S1
E2	mm	130.0	250.0	219.0	115.0	236.8	6.0	5.5
	inch	5.12	9.84	8.62	4.53	9.32	0.24	0.22

Frame F

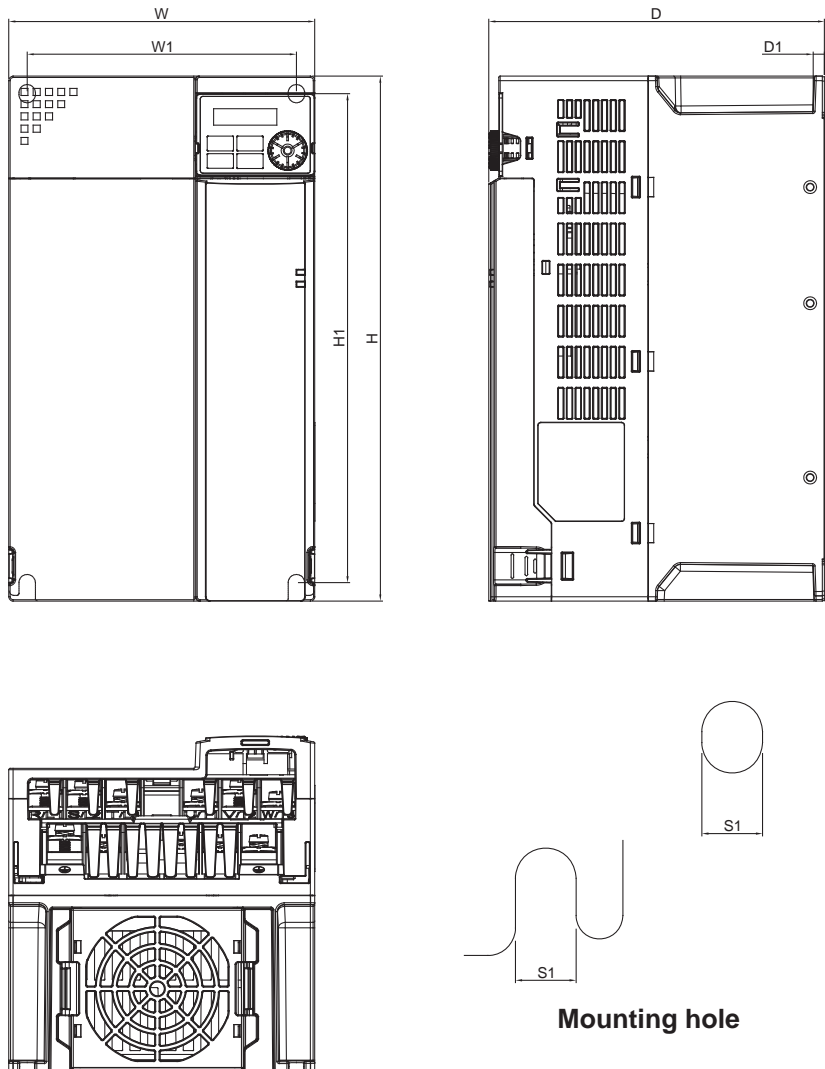

MODEL FRAME F1

Standard Models :
 VFD65AMH23ANSAA
 VFD65AMH23ENSAA
 VFD38AMH43ANSAA
 VFD38AMH43ENSAA
 VFD45AMH43ANSAA
 VFD45AMH43ENSAA

High Speed Models :
 VFD65AMH23ANSHA
 VFD65AMH23ENSHA
 VFD38AMH43ANSHA
 VFD38AMH43ENSHA
 VFD45AMH43ANSHA
 VFD45AMH43ENSHA

FRAME F2

Standard Models :
 VFD38AMH43AFSAA
 VFD45AMH43AFSAA

High Speed Models :
 VFD38AMH43AFSHA
 VFD45AMH43AFSHA

Frame		W	H	D	W1	H1	D1	S1
F1	mm	175.0	300.0	192.0	154.0	279.5	6.5	8.4
	inch	6.89	11.81	7.56	6.06	11.00	0.26	0.33
Frame		W	H	D	W1	H1	D1	S1
F2	mm	175.0	300.0	244.0	154.0	279.5	6.5	8.4
	inch	6.89	11.81	9.61	6.06	11.00	0.26	0.33

MS300 Dimensions

Frame A

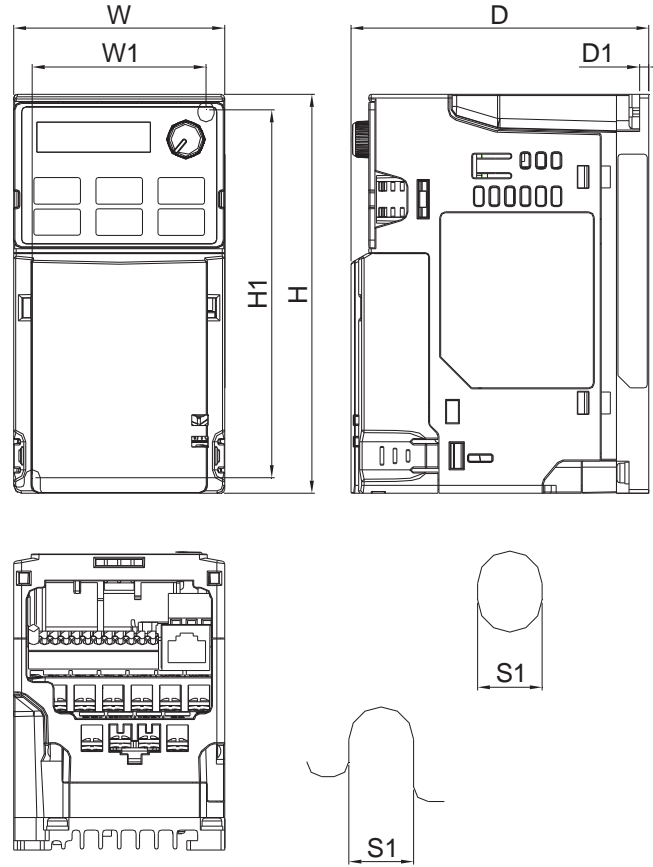

Mounting hole

MODEL	FRAME A1	FRAME A2	FRAME A3	FRAME A4	FRAME A5
VFD1A6MS11ANSAA	VFD2A8MS23ANSAA	VFD2A5MS11ANSAA	VFD1A5MS43ANSAA	VFD4A8MS23ANSAA	
VFD1A6MS11ENSAA	VFD2A8MS23ENSAA	VFD2A5MS11ENSAA	VFD1A5MS43ENSAA	VFD4A8MS23ENSAA	
VFD1A6MS21ANSAA		VFD2A8MS21ANSAA		VFD2A7MS43ANSAA	
VFD1A6MS21ENSAA		VFD2A8MS21ENSAA		VFD2A7MS43ENSAA	
VFD1A6MS23ANSAA					
VFD1A6MS23ENSAA					

Frame	W	H	D	W1	H1	D1	S1	
A1	mm	68.0	128.0	96.0	56.0	118.0	3.0	5.2
	inch	2.68	5.04	3.78	2.20	4.65	0.12	0.20
A2	mm	68.0	128.0	110.0	56.0	118.0	3.0	5.2
	inch	2.68	5.04	4.33	2.20	4.65	0.12	0.20
A3	mm	68.0	128.0	125.0	56.0	118.0	3.0	5.2
	inch	2.68	5.04	4.92	2.20	4.65	0.12	0.20

Frame	W	H	D	W1	H1	D1	S1	
A4	mm	68.0	128.0	129.0	56.0	118.0	3.0	5.2
	inch	2.68	5.04	5.08	2.20	4.65	0.12	0.20
A5	mm	68.0	128.0	143.0	56.0	118.0	3.0	5.2
	inch	2.68	5.04	5.63	2.20	4.65	0.12	0.20

Frame B

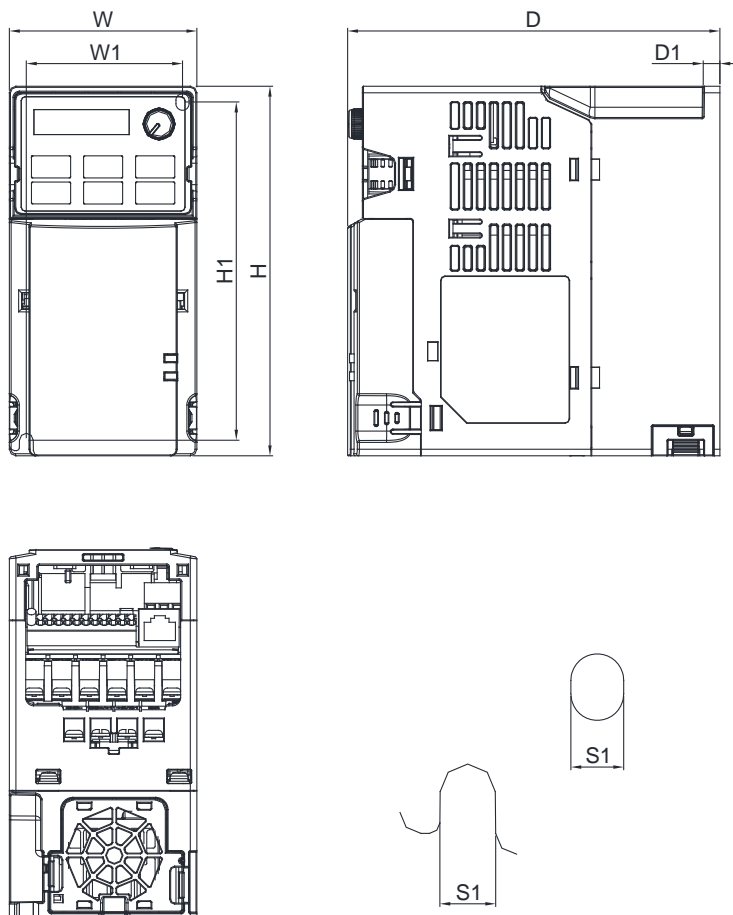

Mounting hole

MODEL FRAME B1

Standard Models :
VFD7A5MS23ANSAA
VFD7A5MS23ENSAA
VFD4A2MS43ANSAA
VFD4A2MS43ENSAA

High Speed Models :
VFD7A5MS23ANSHA
VFD7A5MS23ENSHA
VFD4A2MS43ANSHA
VFD4A2MS43ENSHA

FRAME B2

Standard Models :
VFD4A8MS21ANSAA
VFD4A8MS21ENSAA

FRAME B3

Standard Models :
VFD1A6MS21AFSAA
VFD2A8MS21AFSAA
VFD4A8MS21AFSAA
VFD1A5MS43AFSAA
VFD2A7MS43AFSAA
VFD4A2MS43AFSAA

High Speed Models :
VFD4A2MS43AFSHA

Frame		W	H	D	W1	H1	D1	S1
B1	mm	72.0	142.0	143.0	60.0	130.0	6.4	5.2
	inch	2.83	5.59	5.63	2.36	5.12	0.25	0.20
Frame		W	H	D	W1	H1	D1	S1
B2	mm	72.0	142.0	143.0	60.0	130.0	3.0	5.2
	inch	2.83	5.59	5.63	2.36	5.12	0.12	0.20
Frame		W	H	D	W1	H1	D1	S1
B3	mm	72.0	142.0	159.0	60.0	130.0	4.3	5.2
	inch	2.83	5.59	6.26	2.36	5.12	0.17	0.20

MS300 Dimensions

Frame C

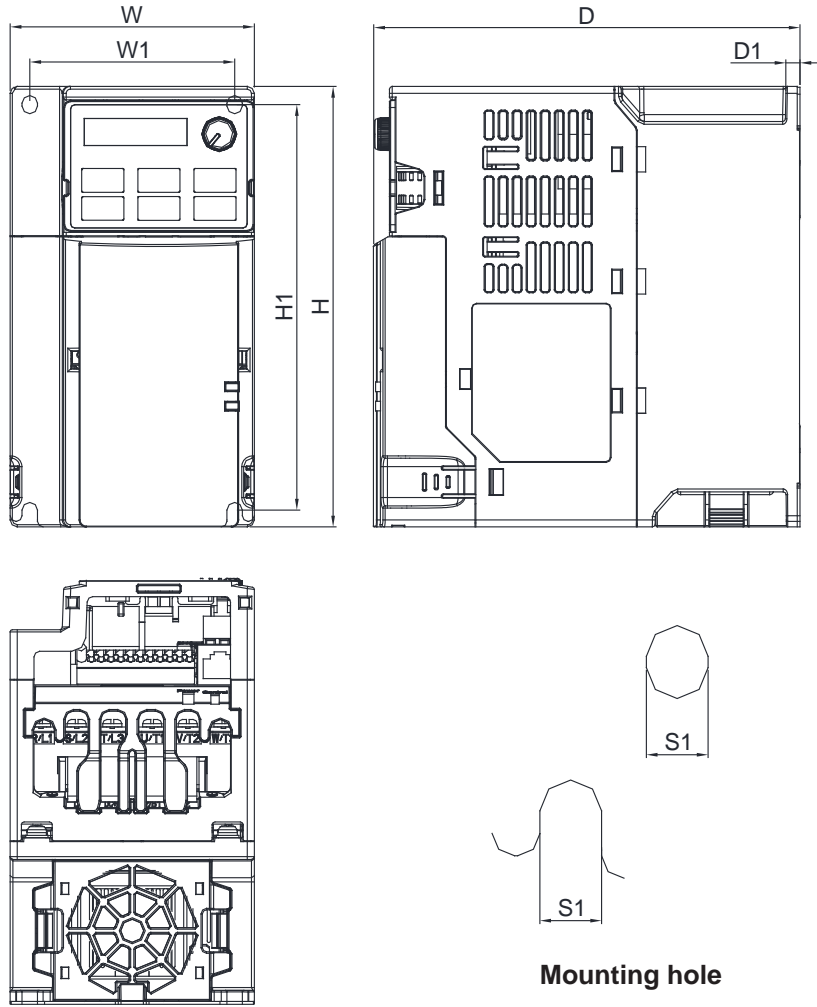

MODEL FRAME C1

Standard Models :
 VFD4A8MS11ANSAA VFD4A8MS11ENSAA
 VFD7A5MS21ANSAA VFD7A5MS21ENSAA
 VFD11AMS21ANSAA VFD11AMS21ENSAA
 VFD11AMS23ANSAA VFD11AMS23ENSAA
 VFD17AMS23ANSAA VFD17AMS23ENSAA
 VFD5A5MS43ANSAA VFD5A5MS43ENSAA
 VFD9A0MS43ANSAA VFD9A0MS43ENSAA

High Speed Models :
 VFD7A5MS21ANSHA VFD7A5MS21ENSHA
 VFD11AMS21ANSHA VFD11AMS21ENSHA
 VFD11AMS23ANSHA VFD11AMS23ENSHA
 VFD17AMS23ANSHA VFD17AMS23ENSHA
 VFD5A5MS43ANSHA VFD5A5MS43ENSHA
 VFD9A0MS43ANSHA VFD9A0MS43ENSHA

FRAME C2

Standard Models :
 VFD7A5MS21AFSAA VFD7A5MS21AFSHA
 VFD11AMS21AFSAA VFD11AMS21AFSHA
 VFD5A5MS43AFSAA VFD5A5MS43AFSHA
 VFD9A0MS43AFSAA VFD9A0MS43AFSHA

Frame		W	H	D	W1	H1	D1	S1
C1	mm	87.0	157.0	152.0	73.0	144.5	5.0	5.5
	inch	3.43	6.18	5.98	2.87	5.69	0.20	0.22
Frame		W	H	D	W1	H1	D1	S1
C2	mm	87.0	157.0	179.0	73.0	144.5	5.0	5.5
	inch	3.43	6.18	7.05	2.87	5.69	0.20	0.22

Frame D

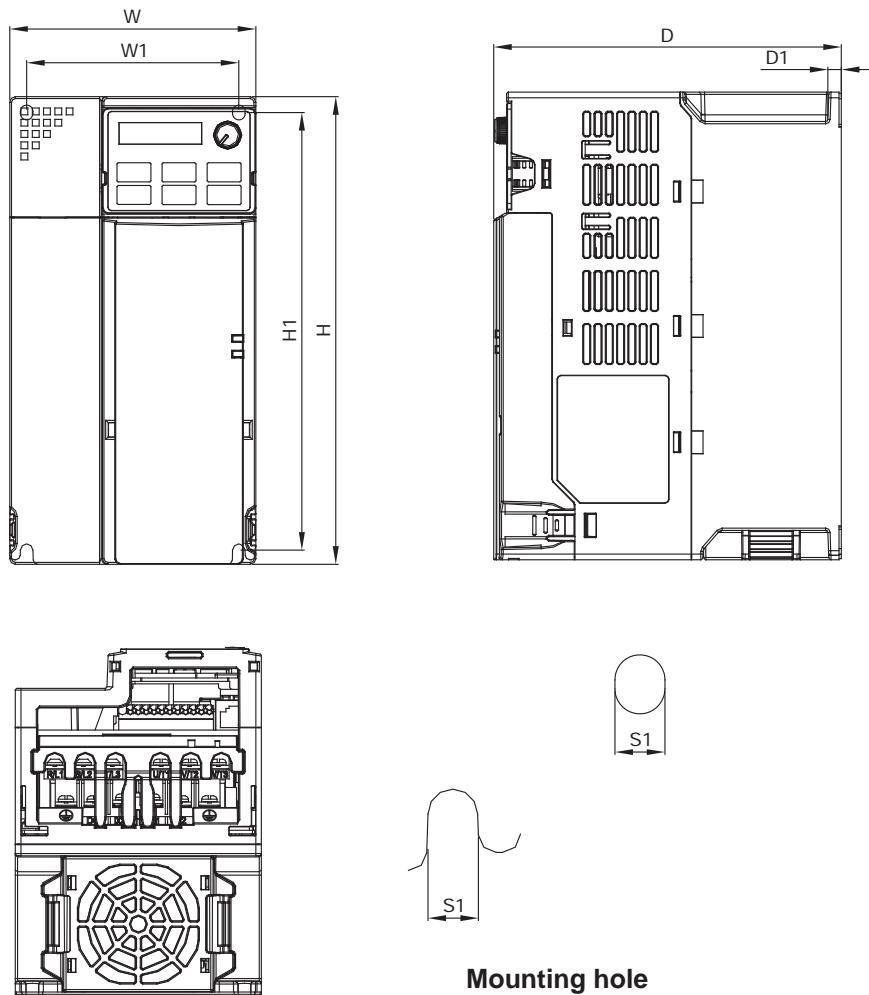

Mounting hole

MODEL FRAME D1

Standard Models :
 VFD25AMS23ANSAA
 VFD25AMS23ENSAA
 VFD13AMS43ANSAA
 VFD13AMS43ENSAA
 VFD17AMS43ANSAA
 VFD17AMS43ENSAA

High Speed Models :
 VFD25AMS23ANSHA
 VFD25AMS23ENSHA
 VFD13AMS43ANSHA
 VFD13AMS43ENSHA
 VFD17AMS43ANSHA
 VFD17AMS43ENSHA

FRAME D2

Standard Models :
 VFD13AMS43AFSAA
 VFD17AMS43AFSAA

High Speed Models :
 VFD13AMS43AFSHA
 VFD17AMS43AFSHA

Frame		W	H	D	W1	H1	D1	S1
D1	mm	109.0	207.0	154.0	94.0	193.8	6.0	5.5
	inch	4.29	8.15	6.06	3.70	7.63	0.24	0.22
Frame		W	H	D	W1	H1	D1	S1
D2	mm	109.0	207.0	187.0	94.0	193.8	6.0	5.5
	inch	4.29	8.15	7.36	3.70	7.63	0.24	0.22

MS300 Dimensions

Frame E

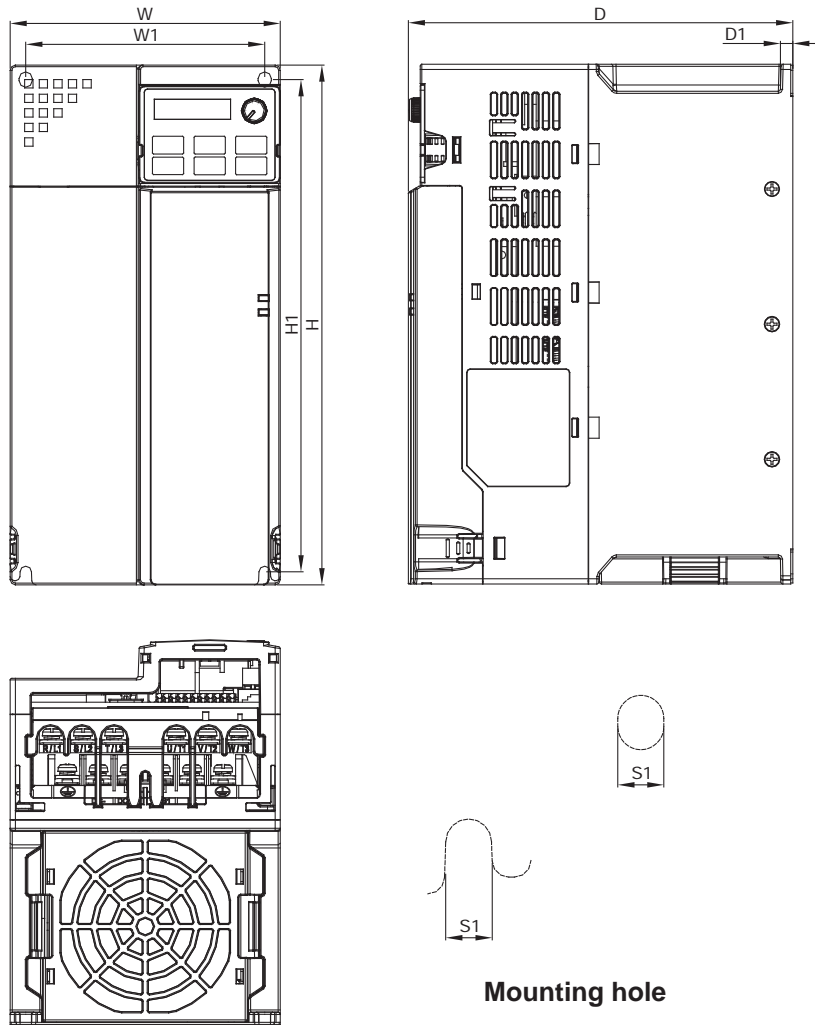

Mounting hole

MODEL FRAME E1

Standard Models :
 VFD33AMS23ANSAA
 VFD33AMS23ENSAA
 VFD49AMS23ANSAA
 VFD49AMS23ENSAA
 VFD25AMS43ANSAA
 VFD25AMS43ENSAA
 VFD32AMS43ANSAA
 VFD32AMS43ENSAA

High Speed Models :
 VFD33AMS23ANSHA
 VFD33AMS23ENSHA
 VFD49AMS23ANSHA
 VFD49AMS23ENSHA
 VFD25AMS43ANSHA
 VFD25AMS43ENSHA
 VFD32AMS43ANSHA
 VFD32AMS43ENSHA

FRAME E2

Standard Models :
 VFD25AMS43AFSAA
 VFD32AMS43AFSAA

High Speed Models :
 VFD25AMS43AFSHA
 VFD32AMS43AFSHA

Frame		W	H	D	W1	H1	D1	S1
E1	mm	130.0	250.0	185.0	115.0	236.8	6.0	5.5
	inch	5.12	9.84	7.83	4.53	9.32	0.24	0.22
Frame		W	H	D	W1	H1	D1	S1
E2	mm	130.0	250.0	219.0	115.0	236.8	6.0	5.5
	inch	5.12	9.84	8.62	4.53	9.32	0.24	0.22

Frame F

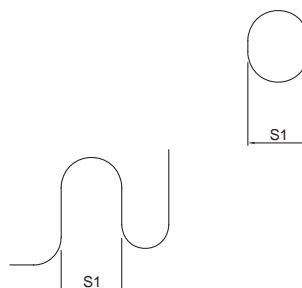
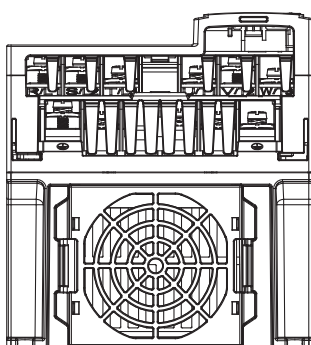
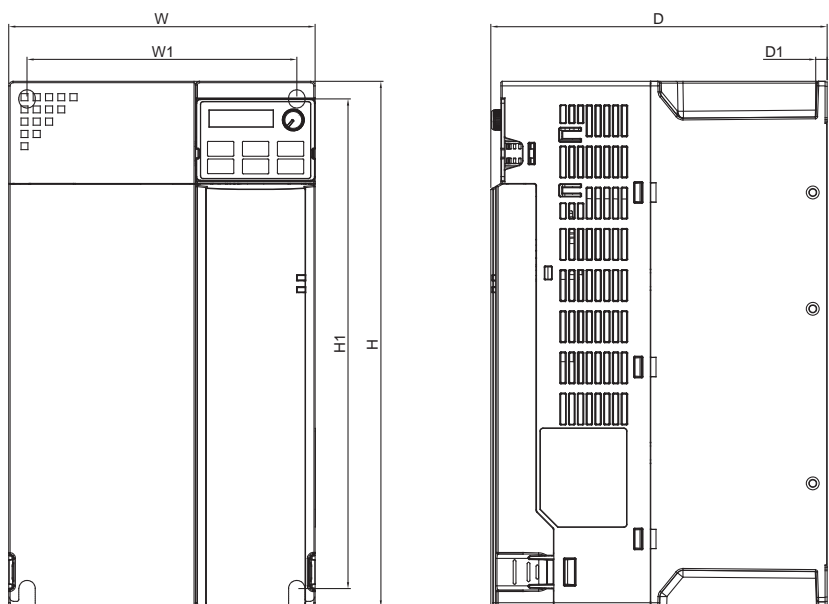

Mounting hole

MODEL FRAME F1

Standard Models :
 VFD65AMS23ANSAA
 VFD65AMS23ENSAA
 VFD38AMS43ANSAA
 VFD38AMS43ENSAA
 VFD45AMS43ANSAA
 VFD45AMS43ENSAA

High Speed Models :
 VFD65AMS23ANSHA
 VFD65AMS23ENSHA
 VFD38AMS43ANSHA
 VFD38AMS43ENSHA
 VFD45AMS43ANSHA
 VFD45AMS43ENSHA

FRAME F2

Standard Models :
 VFD38AMS43AFSAA
 VFD45AMS43AFSAA

High Speed Models :
 VFD38AMS43AFSHA
 VFD45AMS43AFSHA

Frame		W	H	D	W1	H1	D1	S1
F1	mm	175.0	300.0	192.0	154.0	279.5	6.5	8.4
	inch	6.89	11.81	7.56	6.06	11.00	0.26	0.33
Frame		W	H	D	W1	H1	D1	S1
F2	mm	175.0	300.0	244.0	154.0	279.5	6.5	8.4
	inch	6.89	11.81	9.61	6.06	11.00	0.26	0.33

Accessories

■ EMM-PG01L (MH300)

		Terminals	Description
 <p>ABZ (Line Driver) Set by Pr.10-00 ~ 10-02</p>	PG1	VP	Output voltage for power: +5V/+12V ± 5% (use FSW3 to switch +5V/+12V) Max. output current: 200 mA
		DCM	Common for power and signal
		A1,/A1, B1,/B1, Z1,/Z1	Encoder input signal (Line Driver) 1-phase or 2-phase input; Max. input frequency: 300 kP/sec
	PG2	A2,/A2, B2,/B2	Pulse input signal (Line Driver or Open Collector) Open collector input: +5V/+12V (Note1) 1-phase or 2-phase input; Max. input frequency: 300 kP/sec
	PG OUT	AO,/AO, BO,/BO, ZO,/ZO, SG	PG card output signals. Division frequency function: 1 ~ 255 times Max. output voltage for Line driver: 5V _{DC} Max. output current: 50 mA; Max. output frequency: 300 kP/sec SG: The GND of PG card is the same as the host controller or PLC, so a common output signal is attained.
	Ground	PE	Earthing terminal to reduce noise; this terminal should also be grounded.

■ EMM-PG01O (MH300)

		Terminals	Description
 <p>ABZ (Open Collector) Set by Pr.10-00 ~ 10-02</p>	PG1	VP	Output voltage for power: +5V / +12V ± 5% (use SSW320 to switch +5V /+12V) Max. output current: 200 mA
		DCM	Common for power and signal
		A1,/A1, B1,/B1, Z1,/Z1	Encoder input signal (Line Driver or Open Collector) Open collector input: +5V / +12V (Note1) 1-phase or 2-phase input; Max. input frequency: 300 kP/sec
	PG2	A2,/A2, B2,/B2	Pulse input signal (Line Driver or Open Collector) Open collector input : +5V / +12V (Note1) 1-phase or 2-phase input; Max. input frequency: 300 kP/sec
	PG OUT	V+- V- /AO, /BO, /ZO, SG	Needs external power source for PG OUT circuit. Input voltage of power:+7V ~ +24V Negative power supply input PG card output signals. Division frequency function: 1 ~ 255 times Add a pull-up resistor (1.8KΩ / 1W) to the open collector output signals to avoid signal interferences. Max. Output current: 20 mA; Max output frequency: 300 kP/sec SG: The GND of PG card is the same as the host controller or PLC, so a common output signal is attained.
	Ground	PE	Earthing terminal to reduce noise; this terminal should also be grounded.

■ EMM-PG01R (MH300)

		Terminals	Description
 <p>Resolver Set by Pr.10-00 ~ 10-02</p>	PG1	R1- R2	Resolver output power 7 V _{rms} , 10 kHz
		S1,S2, S3, S4	Resolver input signal 3.5 ± 0.175 V _{rms} , 10 kHz
	PG2	A2,/A2, B2,/B2	Pulse input signal (Line Driver or Open Collector) Open collector input : +5V / +12V (Note1) 1-phase or 2-phase input; Max. input frequency: 300 kP/sec
	PG OUT	AO,/AO, BO,/BO, ZO,/ZO, SG	PG card output signals. Division frequency function: 1 ~ 255 times Max. output voltage for Line driver: 5V _{DC} Max. output current: 50 mA, Max. output frequency: 300 kP/sec SG: The GND of PG card is the same as the host controller or PLC, so a common output signal is attained.
	Ground	PE	Earthing terminal to reduce noise; this terminal should also be grounded.

■ EMM-BPS01 (MH300 / MS300)

		Terminals	Description
 <p>24V Power Shift Card</p>		PE GND 24V	When the AC motor drive power is off, the external power supply card provides external power to the network system, PLC function, and other functions to allow continued operations. Input power: 24V ± 5% Maximum input current: 0.5A Note: 1) Do not connect the control terminal +24V (Digital control signal common: SOURCE) directly to the EMC-BPS01 input terminal 24V. 2) Do not connect control terminal GND directly to the EMC-BPS01 input terminal GND in order to achieve good isolation.

Note 1: For the Open Collector, set input voltage to 5 ~ 15 mA and install a pull-up resistor
[5V] Recommend pull-up resistor: 100 ~ 220 Ω, 1 / 2 W and above
[12V] Recommend pull-up resistor: 510 ~ 1.35 KΩ, 1 / 2 W and above
[24V] Recommend pull-up resistor: 1.8K ~ 3.3 KΩ, 1 / 2 W and above

■ **EMM-D33A** (MH300)

 Digital I/O Extension Card	Terminals	Description
	24V \ DCM	Output power: +24 V _{DC} ± 5 % 200 mA, 5 W
	MI10 ~ MI12	Refer to Pr. 02-26 ~ Pr. 02-28 to program the multi-function. Choose SINK (NPN) / SOURCE (PNP) from SWW1. Internal power is supplied by terminal 24V: +24 V _{DC} ± 5% 200 mA, 5 W. If external power is +24 V _{DC} , the max. voltage is 30 V _{DC} and the min. voltage is 19 V _{DC} . ON: the activation current is 6.5 mA. OFF: leakage current tolerance is 10 μA.
	MO10 ~ MO12	Refer to Pr. 02-36 ~ Pr. 02-38 to program the multi-function The motor drive releases various monitor signals, such as drive in operation, frequency attained and overload indication, via transistor (open collector). MO output signal: each MO terminal needs a pull-up resistor, the max. external power voltage is 48 V _{DC} / 50 mA
	MCM	Common for multi-function output terminals MO10 ~ MO12 (photocoupler)
PE	Earthing terminal to reduce noise; this terminal should also be grounded.	

■ **EMM-A22A** (MH300)

 Analog I/O Extension Card	Terminals	Description
	ACM	Common output signal and input signal terminals
	AI10 \ AI11	Refer to Pr. 14-00 ~ Pr. 14-01 to program the multi-function Two AI ports: switch between J9, J19 for AVI or ACI AVI10 ~ AVI11: input 0 ~ 10.00 V ± 0.05 V ACI10 ~ ACI11: input 0 ~ 20.00 mA ± 0.05 mA
	AO10 \ AO11	Refer to Pr. 14-12 ~ Pr. 14-13 to program the multi-function Two AO ports: switch between J2, J22 for AVO or ACO AVO10 ~ AVO11: output 0 ~ 10.00 V ± 0.05 V ACO10 ~ ACO11: output 0 ~ 20.00 mA ± 0.05 mA
	PE	Earthing terminal to reduce noise; this terminal should also be grounded.

■ **EMM-R2CA** (MH300)

 Relay Extension Card	Terminals	Description
	RA10 ~ RA11 RB10 ~ RB11 RC10 ~ RC11	Refer to Pr. 02-36 ~ Pr. 02-37 to program the multi-function Resistive load: 5 A (N.O.) / 240 V _{AC} Function: To output each monitor signal, such as drive is in operation, frequency attained or overload indication.

■ **EMM-R3AA** (MH300)

 Relay Extension Card	Terminals	Description
	RA10 ~ RA12 RC10 ~ RC12	Refer to Pr. 02-36 ~ Pr. 02-38 to program the multi-function Resistive load: 6 A (N.O.) / 250 V _{AC} Function: To output each monitor signal, such as drive is in operation, frequency attained or overload indication.

■ **Screw Specification of Option Card Terminals**

Screw Specification of Option Card Terminals	Wire Gauge	Torque	Screw Specification of Option Card Terminals	Wire Gauge	Torque
EMM-PG01L	30 ~ 16 AWG (0.0509 ~ 1.31 mm ²)	2 Kg-cm [1.74 lb-in]	CMM-COP01	30 ~ 16 AWG (0.0509 ~ 1.31 mm ²)	2 Kg-cm [1.74 lb-in]
EMM-PG01O			CMM-MOD01 / CMM-EIP01		
EMM-PG01R			CMM-EC01		
EMM-A22A			CMM-PD01		
EMM-D33A			CMM-DN01		
EMM-BPS01	30 ~ 16 AWG (0.0509 ~ 1.31 mm ²)	8 Kg-cm [6.94 lb-in]			
EMM-R2CA	24 ~ 12 AWG	5 Kg-cm			
EMM-R3AA	(0.205 ~ 3.31 mm ²)	[4.34 lb-in]			

Accessories

■ CMM-EIP01 (MH300 / MS300)

EtherNet/IP Option Card



Features

- ▶ Supports max. 32 words input and 32 words output of I/O connection
- ▶ User-defined parameter mapping
- ▶ MDI/MDI-X auto-detect
- ▶ IP Filter, basic firewall function
- ▶ E-mail alarm

Network Interface

Network protocol	EtherNet/IP	Interface	RJ-45
Transmission speed	10/100Mbps	Number of port	1
Transmission method	I/O connection/ Explicit message	Transmission cable	Category 5e shielding
Transmission distance	100m, extension is allowed via switch		

■ CMM-MOD01 (MH300 / MS300)

MODBUS TCP Option Card



Features

- ▶ MDI/MDI-X auto-detect
- ▶ IP Filter, basic firewall function
- ▶ E-mail alarm

Network Interface

Network protocol	MODBUS TCP	Interface	RJ-45
Transmission speed	10/100Mbps	Number of port	1
Transmission distance	100m, extension is allowed via switch	Transmission cable	Category 5e shielding

■ CMM-COP01 (MS300)

CANopen Option Card



Features

- ▶ Complies with CiA 402 standard (default setting)
- ▶ 4 sets of RX/TX PDO
- ▶ Dual communication ports
- ▶ Node address and Baud rate can be set in the AC motor drive
- ▶ Supports Delta protocol, DMCNET

Network Interface

Network protocol	CANopen	Interface	RJ-45
Transmission speed	1M/500k/250k/125k/100k/50kbps	Number of port	2
Transmission method	PDO, SDO	Transmission cable	Delta standard
Transmission distance	25m / 1Mbps		

■ CMM-DN01 (MH300 / MS300)

DeviceNet Option Card



Features

- ▶ Support Group 2 only connection method and cyclic I/O data exchange
- ▶ Provides EDS file to identify DeviceNet equipment information
- ▶ Supports max. 32 words input and 32 words output of parameter mapping
- ▶ Node address and Baud rate can be set in the AC motor drive

Network Interface

Network protocol	DeviceNet	Interface	Terminal block
Transmission speed	500k/250k/125k/100k/50k bps and extendable baud rate mode of 1M	Number of port	1
Transmission method	Explicit message/Implicit message	Transmission cable	Delta standard
Transmission distance	25m/1Mbps		

▪ **CMM-PD01** (MH300 / MS300)

PROFIBUS DP Option Card



Features

- ▶ Supports PZD cyclic data exchange
- ▶ Supports user diagnosis function.
- ▶ Supports PKW read/write to AC motor drive parameters
- ▶ Auto-detects baud rates; supports Max. 12 Mbps.

Network Interface

Network protocol	PROFIBUS DP	Interface	DB9
Transmission speed	9.6k / 19.2k / 93.75k / 187.5k / 500k / 1.5M / 3M / 6M / 12Mbps	Number of port	1
Transmission method	Cyclic / non-cyclic data exchange	Transmission cable	Delta standard
Transmission distance	100m / 12Mbps		

▪ **CMM-EC01** (MH300)

EtherCAT Option Card



Features

- ▶ Supports velocity mode
- ▶ Complies with CANopen CiA402 (CoE)
- ▶ Parameter reading/writing
- ▶ Disconnection treatment

Network Interface

Network protocol	EtherCAT	Interface	RJ-45
Transmission speed	100Mbps	Number of port	2
Transmission distance	100m	Transmission cable	Delta standard

▪ **Delta Standard Fieldbus Cables**

Delta Cables	Part Number	Description	Length
CANopen Cable	UC-CMC003-01A	CANopen cable, RJ45 connector	0.3m
	UC-CMC005-01A	CANopen cable, RJ45 connector	0.5m
	UC-CMC010-01A	CANopen cable, RJ45 connector	1m
	UC-CMC015-01A	CANopen cable, RJ45 connector	1.5m
	UC-CMC020-01A	CANopen cable, RJ45 connector	2m
	UC-CMC030-01A	CANopen cable, RJ45 connector	3m
	UC-CMC050-01A	CANopen cable, RJ45 connector	5m
	UC-CMC100-01A	CANopen cable, RJ45 connector	10m
	UC-CMC200-01A	CANopen cable, RJ45 connector	20m
DeviceNet Cable	UC-DN01Z-01A	DeviceNet cable	305m
	UC-DN01Z-02A	DeviceNet cable	305m
Ethernet/EtherCAT Cable	UC-EMC003-02A	Ethernet/EtherCAT cable, Shielding	0.3m
	UC-EMC005-02A	Ethernet/EtherCAT cable, Shielding	0.5m
	UC-EMC010-02A	Ethernet/EtherCAT cable, Shielding	1m
	UC-EMC020-02A	Ethernet/EtherCAT cable, Shielding	2m
	UC-EMC050-02A	Ethernet/EtherCAT cable, Shielding	5m
	UC-EMC100-02A	Ethernet/EtherCAT cable, Shielding	10m
	UC-EMC200-02A	Ethernet/EtherCAT cable, Shielding	20m
CANopen/DeviceNet TAP	TAP-CN01	1 in 2 out, built-in 121Ω terminal resistor	1 in 2 out
	TAP-CN02	1 in 4 out, built-in 121Ω terminal resistor	1 in 4 out
	TAP-CN03	1 in 4 out, RJ45 connector, built-in 121Ω terminal resistor	1 in 4 out
PROFIBUS Cable	UC-PF01Z-01A	PROFIBUS DP cable	305m

Extension Cable for Digital Keypad

MH300 RJ45 Extension Cable / CANOpen Communication Cable

Model: TAP-CB05, TAP-CB10

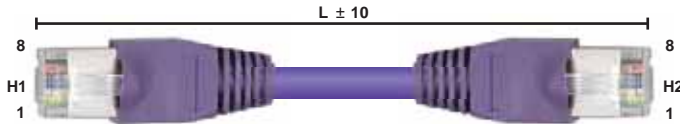

Title	Part No.	L	
		mm	inch
1	UC-CMC003-01A	300	11.8
2	UC-CMC005-01A	500	19.6
3	UC-CMC010-01A	1000	39
4	UC-CMC015-01A	1500	59
5	UC-CMC020-01A	2000	78.7
6	UC-CMC030-01A	3000	118.1
7	UC-CMC050-01A	5000	196.8
8	UC-CMC100-01A	10000	393.7
9	UC-CMC200-01A	20000	787.4

MS300 Extension Cable



Part No.	L	
	mm	[inch]
EG0610C	600	23.6
EG1010C	1000	39.4
EG2010C	2000	78.7
EG3010C	3000	118.1
EG5010C	5000	196.8

Model Name Explanation

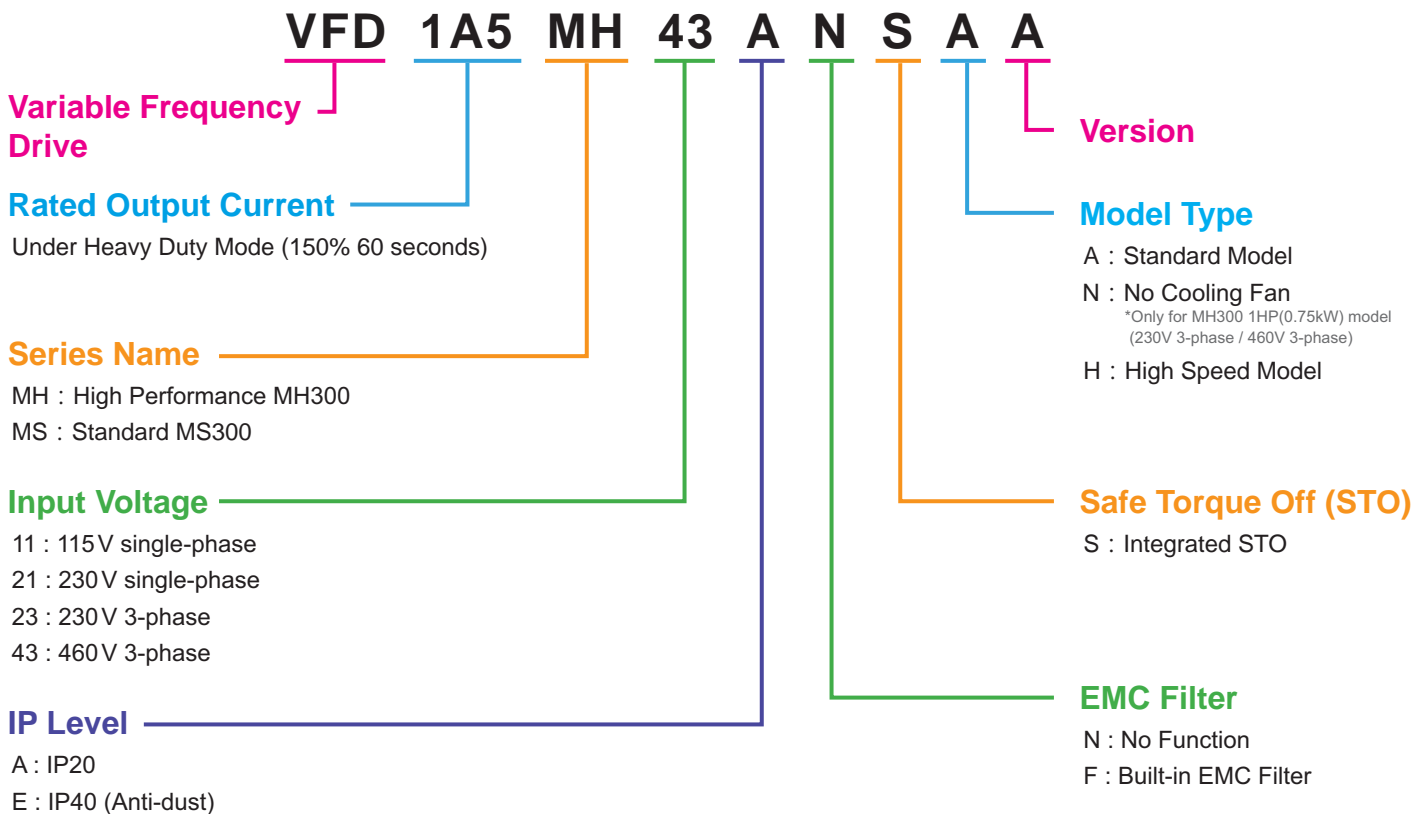

Ordering Information

MH300 Standard Models (0 ~ 599Hz)

Power Range			Frame Size	Model Name	Standard Models (0 ~ 599Hz)		
Max. Applicable Motor Capacity		Drive Rated Output Current			Built-in EMC Filter	IP40 Models	F: Forced air cooling N: Natural air cooling
[HP]	[kW]	[A]					
115V / single-phase							
0.25	0.2	1.6	A	VFD1A6MH11ANSAA	-	-	N
				VFD1A6MH11ENSAA	-	V	N
0.5	0.4	2.5	A	VFD2A5MH11ANSAA	-	-	N
				VFD2A5MH11ENSAA	-	V	N
1	0.75	5.0	C	VFD5A0MH11ANSAA	-	-	F
				VFD5A0MH11ENSAA	-	V	F
230V / single-phase							
0.25	0.2	1.6	A	VFD1A6MH21ANSAA	-	-	N
			A	VFD1A6MH21ENSAA	-	V	N
			B	VFD1A6MH21AFSAA	V	-	N
0.5	0.4	2.8	A	VFD2A8MH21ANSAA	-	-	N
			A	VFD2A8MH21ENSAA	-	V	N
			B	VFD2A8MH21AFSAA	V	-	F
1	0.75	5.0	B	VFD5A0MH21ANSAA	-	-	N
				VFD5A0MH21AFSAA	V	-	F
				VFD5A0MH21ENSAA	-	V	N
2	1.5	7.5	C	VFD7A5MH21ANSAA	-	-	F
				VFD7A5MH21AFSAA	V	-	F
				VFD7A5MH21ENSAA	-	V	F
3	2.2	11.0	C	VFD11AMH21ANSAA	-	-	F
				VFD11AMH21AFSAA	V	-	F
				VFD11AMH21ENSAA	-	V	F
230V / 3-phase							
0.25	0.2	1.6	A	VFD1A6MH23ANSAA	-	-	N
				VFD1A6MH23ENSAA	-	V	N
0.5	0.4	2.8	A	VFD2A8MH23ANSAA	-	-	N
				VFD2A8MH23ENSAA	-	V	N
1	0.75	5.0	A	VFD5A0MH23ANSAA	-	-	F
				VFD5A0MH23ENSAA	-	V	F
				VFD5A0MH23ANSNA			N
				VFD5A0MH23ENSNA		V	N
2	1.5	7.5	B	VFD7A5MH23ANSAA	-	-	F
				VFD7A5MH23ENSAA	-	V	F
3	2.2	11.0	C	VFD11AMH23ANSAA	-	-	F
				VFD11AMH23ENSAA	-	V	F
5	3.7/4	17.0	C	VFD17AMH23ANSAA	-	-	F
				VFD17AMH23ENSAA	-	V	F
7.5	5.5	25.0	D	VFD25AMH23ANSAA	-	-	F
				VFD25AMH23ENSAA	-	V	F
10	7.5	33.0	E	VFD33AMH23ANSAA	-	-	F
				VFD33AMH23ENSAA	-	V	F
15	11	49.0	E	VFD49AMH23ANSAA	-	-	F
				VFD49AMH23ENSAA	-	V	F
20	15	65.0	F	VFD65AMH23ANSAA	-	-	F
				VFD65AMH23ENSAA	-	V	F

Ordering Information

MH300 Standard Models (0 ~ 599 Hz)

Power Range			Frame Size	Model Name	Standard Models (0 ~ 599 Hz)		
Max. Applicable Motor Capacity		Drive Rated Output Current			Built-in EMC Filter	IP40 Models	F: Forced air cooling N: Natural air cooling
[HP]	[kW]	[A]					
460 V / 3-phase							
0.5	0.4	1.5	A	VFD1A5MH43ANSAA	-	-	N
			A	VFD1A5MH43ENSAA	-	V	N
			B	VFD1A5MH43AFSAA	V	-	F
1	0.75	3.0	A	VFD3A0MH43ANSAA	-	-	F
			A	VFD3A0MH43ENSAA	-	V	F
			B	VFD3A0MH43AFSAA	V	-	F
			A	VFD3A0MH43ANSNA			N
			A	VFD3A0MH43ENSNA		V	N
2	1.5	4.2	B	VFD4A2MH43ANSAA	-	-	F
				VFD4A2MH43ENSAA	-	V	F
				VFD4A2MH43AFSAA	V	-	F
3	2.2	5.7	C	VFD5A7MH43ANSAA	-	-	F
				VFD5A7MH43ENSAA	-	V	F
				VFD5A7MH43AFSAA	V	-	F
5	3.7/4	9.0	C	VFD9A0MH43ANSAA	-	-	F
				VFD9A0MH43ENSAA	-	V	F
				VFD9A0MH43AFSAA	V	-	F
7.5	5.5	13.0	D	VFD13AMH43ANSAA	-	-	F
				VFD13AMH43ENSAA	-	V	F
				VFD13AMH43AFSAA	V	-	F
10	7.5	17.5	D	VFD17AMH43ANSAA	-	-	F
				VFD17AMH43ENSAA	-	V	F
				VFD17AMH43AFSAA	V	-	F
15	11	25.0	E	VFD25AMH43ANSAA	-	-	F
				VFD25AMH43ENSAA	-	V	F
				VFD25AMH43AFSAA	V	-	F
20	15	32.0	E	VFD32AMH43ANSAA	-	-	F
				VFD32AMH43ENSAA	-	V	F
				VFD32AMH43AFSAA	V	-	F
25	18.5	38.0	F	VFD38AMH43ANSAA	-	-	F
				VFD38AMH43ENSAA	-	V	F
				VFD38AMH43AFSAA	V	-	F
30	22	45.0	F	VFD45AMH43ANSAA	-	-	F
				VFD45AMH43ENSAA	-	V	F
				VFD45AMH43AFSAA	V	-	F

MH300 High Speed Models (0 ~ 2000 Hz)

Power Range			Frame Size	Model Name	High Speed Models (0 ~ 2000 Hz)		
Max. Applicable Motor Capacity		Drive Rated Output Current			Built-in EMC Filter	IP40 Models	F: Forced air cooling N: Natural air cooling
[HP]	[kW]	[A]					
230V / single-phase							
2	1.5	7.5	C	VFD7A5MH21ANSHA	-	-	F
				VFD7A5MH21ENSHA	-	V	F
				VFD7A5MH21AFSHA	V	-	F
3	2.2	11.0	C	VFD11AMH21ANSHA	-	-	F
				VFD11AMH21ENSHA	-	V	F
				VFD11AMH21AFSHA	V	-	F
230V / 3-phase							
2	1.5	7.5	B	VFD7A5MH23ANSHA	-	-	F
				VFD7A5MH23ENSHA	-	V	F
3	2.2	11.0	C	VFD11AMH23ANSHA	-	-	F
				VFD11AMH23ENSHA	-	V	F
5	3.7/4	17.0	C	VFD17AMH23ANSHA	-	-	F
				VFD17AMH23ENSHA	-	V	F
7.5	5.5	25.0	D	VFD25AMH23ANSHA	-	-	F
				VFD25AMH23ENSHA	-	V	F
10	7.5	33.0	E	VFD33AMH23ANSHA	-	-	F
				VFD33AMH23ENSHA	-	V	F
15	11	49.0	E	VFD49AMH23ANSHA	-	-	F
				VFD49AMH23ENSHA	-	V	F
20	15	65.0	F	VFD65AMH23ANSHA	-	-	F
				VFD65AMH23ENSHA	-	V	F
460V / 3-phase							
2	1.5	4.2	B	VFD4A2MH43ANSHA	-	-	F
				VFD4A2MH43ENSHA	-	V	F
				VFD4A2MH43AFSHA	V	-	F
3	2.2	5.7	C	VFD5A7MH43ANSHA	-	-	F
				VFD5A7MH43ENSHA	-	V	F
				VFD5A7MH43AFSHA	V	-	F
5	3.7/4	9.0	C	VFD9A0MH43ANSHA	-	-	F
				VFD9A0MH43ENSHA	-	V	F
				VFD9A0MH43AFSHA	V	-	F
7.5	5.5	13.0	D	VFD13AMH43ANSHA	-	-	F
				VFD13AMH43ENSHA	-	V	F
				VFD13AMH43AFSHA	V	-	F
10	7.5	17.5	D	VFD17AMH43ANSHA	-	-	F
				VFD17AMH43ENSHA	-	V	F
				VFD17AMH43AFSHA	V	-	F
15	11	25.0	E	VFD25AMH43ANSHA	-	-	F
				VFD25AMH43ENSHA	-	V	F
				VFD25AMH43AFSHA	V	-	F
20	15	32.0	E	VFD32AMH43ANSHA	-	-	F
				VFD32AMH43ENSHA	-	V	F
				VFD32AMH43AFSHA	V	-	F
25	18.5	38.0	F	VFD38AMH43ANSHA	-	-	F
				VFD38AMH43ENSHA	-	V	F
				VFD38AMH43AFSHA	V	-	F
30	22	45.0	F	VFD45AMH43ANSHA	-	-	F
				VFD45AMH43ENSHA	-	V	F
				VFD45AMH43AFSHA	V	-	F

Ordering Information

MS300 Standard Models (0 ~ 599 Hz)

Power Range			Frame Size	Model Name	Standard Models (0 ~ 599 Hz)	
Max. Applicable Motor Capacity		Drive Rated Output Current			Built-in EMC Filter	IP40 Models
[HP]	[kW]	[A]				
115V / single-phase						
0.25	0.2	1.6	A	VFD1A6MS11ANSAA	-	-
				VFD1A6MS11ENSAA	-	V
0.5	0.4	2.5	A	VFD2A5MS11ANSAA	-	-
				VFD2A5MS11ENSAA	-	V
1	0.75	4.8	C	VFD4A8MS11ANSAA	-	-
				VFD4A8MS11ENSAA	-	V
230V / single-phase						
1/4	0.2	1.6	A	VFD1A6MS21ANSAA	-	-
			A	VFD1A6MS21ENSAA	-	V
			B	VFD1A6MS21AFSAA	V	-
0.5	0.4	2.8	A	VFD2A8MS21ANSAA	-	-
			A	VFD2A8MS21ENSAA	-	V
			B	VFD2A8MS21AFSAA	V	-
1	0.75	4.8	B	VFD4A8MS21ANSAA	-	-
				VFD4A8MS21AFSAA	V	-
				VFD4A8MS21ENSAA	-	V
2	1.5	7.5	C	VFD7A5MS21ANSAA	-	-
				VFD7A5MS21AFSAA	V	-
				VFD7A5MS21ENSAA	-	V
3	2.2	11.0	C	VFD11AMS21ANSAA	-	-
				VFD11AMS21AFSAA	V	-
				VFD11AMS21ENSAA	-	V
230V / 3-phase						
0.25	0.2	1.6	A	VFD1A6MS23ANSAA	-	-
				VFD1A6MS23ENSAA	-	V
0.5	0.4	2.8	A	VFD2A8MS23ANSAA	-	-
				VFD2A8MS23ENSAA	-	V
1	0.75	4.8	A	VFD4A8MS23ANSAA	-	-
				VFD4A8MS23ENSAA	-	V
2	1.5	7.5	B	VFD7A5MS23ANSAA	-	-
				VFD7A5MS23ENSAA	-	V
3	2.2	11.0	C	VFD11AMS23ANSAA	-	-
				VFD11AMS23ENSAA	-	V
5	3.7/4	17.0	C	VFD17AMS23ANSAA	-	-
				VFD17AMS23ENSAA	-	V
7.5	5.5	25.0	D	VFD25AMS23ANSAA	-	-
				VFD25AMS23ENSAA	-	V
10	7.5	33.0	E	VFD33AMS23ANSAA	-	-
				VFD33AMS23ENSAA	-	V
15	11	49.0	E	VFD49AMS23ANSAA	-	-
				VFD49AMS23ENSAA	-	V
20	15	65.0	F	VFD65AMS23ANSAA	-	-
				VFD65AMS23ENSAA	-	V

MS300 Standard Models (0 ~ 599 Hz)

Power Range			Frame Size	Model Name	Standard Models (0 ~ 599 Hz)	
Max. Applicable Motor Capacity		Drive Rated Output Current			Built-in EMC Filter	IP40 Models
[HP]	[kW]	[A]				
460V / 3-phase						
0.5	0.4	1.5	A	VFD1A5MS43ANSAA	-	-
			A	VFD1A5MS43ENSAA	-	V
			B	VFD1A5MS43AFSAA	V	-
1	0.75	2.7	A	VFD2A7MS43ANSAA	-	-
			A	VFD2A7MS43ENSAA	-	V
			B	VFD2A7MS43AFSAA	V	-
2	1.5	4.2	B	VFD4A2MS43ANSAA	-	-
				VFD4A2MS43ENSAA	-	V
				VFD4A2MS43AFSAA	V	-
3	2.2	5.5	C	VFD5A5MS43ANSAA	-	-
				VFD5A5MS43ENSAA	-	V
				VFD5A5MS43AFSAA	V	-
5	3.7/4	9.0	C	VFD9A0MS43ANSAA	-	-
				VFD9A0MS43ENSAA	-	V
				VFD9A0MS43AFSAA	V	-
7.5	5.5	13.0	D	VFD13AMS43ANSAA	-	-
				VFD13AMS43ENSAA	-	V
				VFD13AMS43AFSAA	V	-
10	7.5	17.0	D	VFD17AMS43ANSAA	-	-
				VFD17AMS43ENSAA	-	V
				VFD17AMS43AFSAA	V	-
15	11	25.0	E	VFD25AMS43ANSAA	-	-
				VFD25AMS43ENSAA	-	V
				VFD25AMS43AFSAA	V	-
20	15	32.0	E	VFD32AMS43ANSAA	-	-
				VFD32AMS43ENSAA	-	V
				VFD32AMS43AFSAA	V	-
25	18.5	38.0	F	VFD38AMS43ANSAA	-	-
				VFD38AMS43ENSAA	-	V
				VFD38AMS43AFSAA	V	-
30	22	45.0	F	VFD45AMS43ANSAA	-	-
				VFD45AMS43ENSAA	-	V
				VFD45AMS43AFSAA	V	-

Ordering Information

MS300 High Speed Models (0 ~ 1500Hz)

Power Range			Frame Size	Model Name	High Speed Models (0 ~ 1500Hz)	
Max. Applicable Motor Capacity		Drive Rated Output Current			Built-in EMC Filter	IP40 Models
[HP]	[kW]	[A]				
230V / single-phase						
2	1.5	7.5	C	VFD7A5MS21ANSHA	-	-
				VFD7A5MS21ENSHA	-	V
				VFD7A5MS21AFSHA	V	-
3	2.2	11.0	C	VFD11AMS21ANSHA	-	-
				VFD11AMS21ENSHA	-	V
				VFD11AMS21AFSHA	V	-
230V / 3-phase						
2	1.5	7.5	B	VFD7A5MS23ANSHA	-	-
				VFD7A5MS23ENSHA	-	V
3	2.2	11.0	C	VFD11AMS23ANSHA	-	-
				VFD11AMS23ENSHA	-	V
5	3.7/4	17.0	C	VFD17AMS23ANSHA	-	-
				VFD17AMS23ENSHA	-	V
7.5	5.5	25.0	D	VFD25AMS23ANSHA	-	-
				VFD25AMS23ENSHA	-	V
10	7.5	33.0	E	VFD33AMS23ANSHA	-	-
				VFD33AMS23ENSHA	-	V
15	11	49.0	E	VFD49AMS23ANSHA	-	-
				VFD49AMS23ENSHA	-	V
20	15	65.0	F	VFD65AMS23ANSHA	-	-
				VFD65AMS23ENSHA	-	V
460V / 3-phase						
2	1.5	4.2	B	VFD4A2MS43ANSHA	-	-
				VFD4A2MS43ENSHA	-	V
				VFD4A2MS43AFSHA	V	-
3	2.2	5.5	C	VFD5A5MS43ANSHA	-	-
				VFD5A5MS43ENSHA	-	V
				VFD5A5MS43AFSHA	V	-
5	3.7/4	9.0	C	VFD9A0MS43ANSHA	-	-
				VFD9A0MS43ENSHA	-	V
				VFD9A0MS43AFSHA	V	-
7.5	5.5	13.0	D	VFD13AMS43ANSHA	-	-
				VFD13AMS43ENSHA	-	V
				VFD13AMS43AFSHA	V	-
10	7.5	17.0	D	VFD17AMS43ANSHA	-	-
				VFD17AMS43ENSHA	-	V
				VFD17AMS43AFSHA	V	-
15	11	25.0	E	VFD25AMS43ANSHA	-	-
				VFD25AMS43ENSHA	-	V
				VFD25AMS43AFSHA	V	-
20	15	32.0	E	VFD32AMS43ANSHA	-	-
				VFD32AMS43ENSHA	-	V
				VFD32AMS43AFSHA	V	-
25	18.5	38.0	F	VFD38AMS43ANSHA	-	-
				VFD38AMS43ENSHA	-	V
				VFD38AMS43AFSHA	V	-
30	22	45.0	F	VFD45AMS43ANSHA	-	-
				VFD45AMS43ENSHA	-	V
				VFD45AMS43AFSHA	V	-



Attention

Standard Motors

Used with 400V Standard Motors

It is recommended to add an AC output reactor when using with a 400V standard motor to prevent damage to motor insulation.

Torque Characteristics and Temperature Rise

When a standard motor is drive controlled, the motor temperature will be higher than with DOL operation.

Please reduce the motor output torque when operating at low speeds to compensate for less cooling efficiency.

For continuous constant torque at low speeds, external forced motor cooling is recommended.

Vibration

When the motor drives the machine, resonances may occur, including machine resonances. Abnormal vibration may occur when operating a 2-pole motor at 60Hz or higher.

Noise

When a standard motor is drive controlled, the motor noise will be higher than with DOL operation.

To lower the noise, please increase the carrier frequency of the drive. The motor fan can be very noisy when the motor speed exceeds 60Hz.

Special Motors

High-speed Motor

To ensure safety, please try the frequency setting with another motor before operating the high-speed motor at 120Hz or higher.

Explosion-proof Motor

Please use a motor and drive that comply with explosion-proof requirements.

Submersible Motor & Pump

The rated current is higher than that of a standard motor.

Please check before operation and select the capacity of the AC motor drive carefully.

The motor temperature characteristics differ from a standard motor, please set the motor thermal time constant to a lower value.

Brake Motor

When the motor is equipped with a mechanical brake, the brake should be powered by the mains supply.

Damage may occur when the brake is powered by the drive output. Please DO NOT drive the motor with the brake engaged.

Gear Motor

In gearboxes or reduction gears, lubrication may be reduced if the motor is continuously operated at low speeds.

Please DO NOT operate in this way.

Synchronous Motor

These motors need suitable software for control. Please contact Delta for more information.

Single-phase Motor

Single-phase motors are not suitable for being operated by an AC Motor Drive. Please use a 3-phase motor instead when necessary.

Environmental Conditions

Installation Position

1. The drive is suitable for installation in a place with ambient temperature from -10 to 50^oC.
2. The surface temperature of the drive and brake resistor will rise under specific operation conditions. Therefore, please install the drive on materials that are noncombustible.
3. Ensure that the installation site complies with the ambient conditions as stated in the manual.

Wiring

Limit of Wiring Distance

For remote operation, please use twist-shielding cable and the distance between the drive and control box should be less than 20m.

Maximum Motor Cable Length

Motor cables that are too long may cause overheating of the drive or current peaks due to stray capacitance.

Please ensure that the motor cable is less than 30m.

If the cable length can't be reduced, please lower the carrier frequency or use an AC reactor.

Choose the Right Cable

Please refer to current value to choose the right cable section with enough capacity or use recommended cables.

Grounding

Please ground the drive completely by using the grounding terminal.

How to Choose the Drive Capacity

Standard Motor

Please select the drive according to applicable motor rated current listed in the drive specification.

Please select the next higher power AC drive in case higher starting torque or quick acceleration/deceleration is needed.

Special Motor

Please select the drive according to: Rated current of the drive > rated current of the motor

Transportation and Storage

Please transport and store the drive in a place that meets environment specifications.

Peripheral Equipment

Molded-Case Circuit Breakers (MCCB)

Please install the recommended MCCB or ELCB in the main circuit of the drive and make sure that the capacity of the breaker is equal to or lower than the recommended one.

Add a Magnetic Contactor(MC) in the Output Circuit

When a MC is installed in the output circuit of the drive to switch the motor to commercial power or other purposes, please make sure that the drive and motor are completely stopped and remove the surge absorbers from the MC before switching it.

Add a Magnetic Contactor (MC) in the Input Circuit

Please only switch the MC ONCE per hour or it may damage the drive. Please use RUN/STOP signal to switch many times during motor operation.

Motor Protection

The thermal protection function of the drive can be used to protect the motor by setting the operation level and motor type (standard motor or variable motor). When using a high-speed motor or a water-cooled motor the thermal time constant should be set to a lower value.

When using a longer cable to connect the motor thermal relay to a motor, high-frequency currents may enter via the stray capacitance.

It may result in malfunctioning of the relay as the real current is lower than the setting of thermal relay. Under this condition, please lower the carrier frequency or add an AC reactor to solve this.

DO NOT Use Capacitors to Improve the Power Factor

Use a DC reactor to improve the power factor of the drive. Please DO NOT install power factor correction capacitors on the main circuit of the drive to prevent motor faults due to over current.

Do NOT Use Surge Absorber

Please DO NOT install surge absorbers on the output circuit of the drive.

Lower the Noise

To ensure compliance with EMC regulations, usually a filter and shielded wiring is used to lower the noise.

Method Used to Reduce the Surge Current

Surge currents may occur in the phase-lead capacitor of the power system, causing an overvoltage when the drive is stopped or at low loads.

It is recommended to add a DC reactor to the drive.



Smarter. Greener. Together.

Industrial Automation Headquarters

Delta Electronics, Inc.

Taoyuan Technology Center
18 Xinglong Road, Taoyuan District,
Taoyuan City 33068, Taiwan (R.O.C.)
TEL: 886-3-362-6301 / FAX: 886-3-371-6301

Asia

Delta Electronics (Jiangsu) Ltd.

Wujiang Plant 3
1688 Jiangxing East Road,
Wujiang Economic Development Zone
Wujiang City, Jiang Su Province, P.R.C. 215200
TEL: 86-512-6340-3008 / FAX: 86-769-6340-7290

Delta Greentech (China) Co., Ltd.

238 Min-Xia Road, Pudong District,
ShangHai, P.R.C. 201209
TEL: 86-21-58635678 / FAX: 86-21-58630003

Delta Electronics (Japan), Inc.

Tokyo Office
2-1-14 Minato-ku Shibadaimon,
Tokyo 105-0012, Japan
TEL: 81-3-5733-1111 / FAX: 81-3-5733-1211

Delta Electronics (Korea), Inc.

1511, Byucksan Digital Valley 6-cha, Gasan-dong,
Geumcheon-gu, Seoul, Korea, 153-704
TEL: 82-2-515-5303 / FAX: 82-2-515-5302

Delta Electronics Int'l (S) Pte Ltd.

4 Kaki Bukit Ave 1, #05-05, Singapore 417939
TEL: 65-6747-5155 / FAX: 65-6744-9228

Delta Electronics (India) Pvt. Ltd.

Plot No 43 Sector 35, HSIIDC
Gurgaon, PIN 122001, Haryana, India
TEL : 91-124-4874900 / FAX : 91-124-4874945

Americas

Delta Products Corporation (USA)

Raleigh Office
P.O. Box 12173, 5101 Davis Drive,
Research Triangle Park, NC 27709, U.S.A.
TEL: 1-919-767-3800 / FAX: 1-919-767-8080

Delta Greentech (Brasil) S.A.

Sao Paulo Office
Rua Itapeva, 26 - 3° andar Edificio Itapeva One-Bela Vista
01332-000-São Paulo-SP-Brazil
TEL: 55 11 3568-3855 / FAX: 55 11 3568-3865

Europe

Delta Electronics (Netherlands) B.V.

Eindhoven Office
De Witbogt 20, 5652 AG Eindhoven, The Netherlands
TEL: +31 (0)40-8003800 / FAX: +31 (0)40-8003898

*We reserve the right to change the information in this catalogue without prior notice.